



IVI-4.1: IviScope Class Specification

October 14, 2016 Edition
Revision 4.1



Important Information

The IviScope Class Specification (IVI-4.1) is authored by the IVI Foundation member companies. For a vendor membership roster list, please visit the IVI Foundation web site at www.ivifoundation.org.

The IVI Foundation wants to receive your comments on this specification. You can contact the Foundation through the web site at www.ivifoundation.org.

Warranty

The IVI Foundation and its member companies make no warranty of any kind with regard to this material, including, but not limited to, the implied warranties of merchantability and fitness for a particular purpose. The IVI Foundation and its member companies shall not be liable for errors contained herein or for incidental or consequential damages in connection with the furnishing, performance, or use of this material.

Trademarks

Product and company names listed are trademarks or trade names of their respective companies.

No investigation has been made of common-law trademark rights in any work.

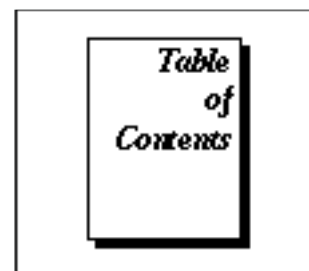

IviScope Class Specification	8
1.Overview of the IviScope Specification.....	11
1.1.Introduction	11
1.2.IviScope Class Overview	11
1.3.References	11
1.4.Definitions of Terms and Acronyms	12
2.IviScope Class Capabilities	13
2.1.Introduction	13
2.2.IviScope Group Names	13
2.3.Repeated Capability Names	14
2.3.1.Channel	14
2.4.Boolean Attribute and Parameter Values	14
2.5..NET Namespace	14
2.6..NET IviScope Session Factory.....	14
3.General Requirements	18
3.1.Minimum Class Compliance	18
3.1.1.Disable	18

3.2.Capability Group Compliance.....	18
4.IviScopeBase Capability Group	19
4.1.Overview	19
4.1.1.Channel Sub-System	19
4.1.2.Acquisition Sub-System	19
4.1.3.Trigger Sub-System	21
4.2.IviScopeBase Attributes	23
4.2.1.Acquisition Start Time	24
4.2.2.Acquisition Status (IVI.NET Only)	26
4.2.3.Acquisition Type	28
4.2.4.Channel Count	33
4.2.5.Channel Enabled	35
4.2.6.Channel Item (IVI-COM & IVI.NET Only)	37
4.2.7.Channel Name (IVI-COM & IVI.NET Only).....	39
4.2.8.Horizontal Minimum Number of Points	41
4.2.9.Horizontal Record Length	43
4.2.10.Horizontal Sample Rate	45
4.2.11.Horizontal Time Per Record	47
4.2.12.Input Impedance	49
4.2.13.Maximum Input Frequency.....	51
4.2.14.Measurement Channel Count (IVI-COM Only)	53
4.2.15.Measurement Channel Item (IVI-COM Only)	55
4.2.16.Probe Attenuation	57
4.2.17.Trigger Coupling	60
4.2.18.Trigger Holdoff	64
4.2.19.Trigger Level	66
4.2.20.Trigger Slope	68
4.2.21.Trigger Source	70
4.2.22.Trigger Type	75
4.2.23.Vertical Coupling	80
4.2.24.Vertical Offset	83
4.2.25.Vertical Range	85
4.3.IviScopeBase Functions	87
4.3.1.Abort	88
4.3.2.Acquisition Status (IVI-C & IVI-COM Only).....	89
4.3.3.Actual Record Length (IVI-C only).....	91
4.3.4.Configure Acquisition Record	92
4.3.5.Configure Acquisition Type (IVI-C only)	93
4.3.6.Configure Channel	94
4.3.7.Create Waveform (IVI.NET Only)	96
4.3.8.Configure Channel Characteristics	97
4.3.9.Configure Edge Trigger Source	98
4.3.10.Configure Trigger	99
4.3.11.Configure Trigger Coupling (IVI-C only)	100
4.3.12.Get Channel Name (IVI-C Only).....	101
4.3.13.Fetch Waveform	102
4.3.14.Initiate Acquisition	105
4.3.15.Is Waveform Element Invalid (IVI-C & IVI-COM Only).....	106
4.3.16.Read Waveform	108
4.3.17.Sample Rate (IVI-C only)	113
4.4.IviScope Behavior Model.....	114
5.IviScopeInterpolation Extension Group	116
5.1.IviScopeInterpolation Overview	116
5.2.IviScopeInterpolation Attributes	116

5.2.1. Interpolation	117
5.3. IviScopeInterpolation Functions	120
5.3.1. Configure Interpolation (IVI-C only)	120
5.4. IviScopeInterpolation Behavior Model	121
6. IviScopeTVTrigger Extension Group	122
6.1. IviScopeTVTrigger Overview	122
6.2. IviScopeTVTrigger Attributes	122
6.2.1. TV Trigger Event	123
6.2.2. TV Trigger Line Number	127
6.2.3. TV Trigger Polarity	129
6.2.4. TV Trigger Signal Format	131
6.3. IviScopeTVTrigger Functions	134
6.3.1. Configure TV Trigger Line Number (IVI-C only)	135
6.3.2. Configure TV Trigger Source	136
6.4. IviScopeTVTrigger Behavior Model	138
6.5. IviScopeTVTrigger Compliance Notes	138
7. IviScopeRuntTrigger Extension Group	139
7.1. IviScopeRuntTrigger Overview	139
7.2. IviScopeRuntTrigger Attributes	139
7.2.1. Runt High Threshold	140
7.2.2. Runt Low Threshold	142
7.2.3. Runt Polarity	144
7.3. IviScopeRuntTrigger Functions	147
7.3.1. ConfigureRuntTriggerSource	148
7.4. IviScopeRuntTrigger Behavior Model	150
7.5. IviScopeRuntTrigger Compliance Notes	150
8. IviScopeGlitchTrigger Extension Group	151
8.1. IviScopeGlitchTrigger Overview	151
8.2. IviScopeGlitchTrigger Attributes	152
8.2.1. Glitch Condition	153
8.2.2. Glitch Polarity	155
8.2.3. Glitch Width	158
8.3. IviScopeGlitchTrigger Functions	160
8.3.1. Configure Glitch Trigger Source	161
8.4. IviScopeGlitchTrigger Behavior Model	163
8.5. IviScopeGlitchTrigger Compliance Notes	163
9. IviScopeWidthTrigger Extension Group	164
9.1. IviScopeWidthTrigger Overview	164
9.2. IviScopeWidthTrigger Attributes	164
9.2.1. Width Condition	166
9.2.2. Width High Threshold	168
9.2.3. Width Low Threshold	170
9.2.4. Width Polarity	172
9.3. IviScopeWidthTrigger Functions	175
9.3.1. Configure Width Trigger Source	176
9.4. IviScopeWidthTrigger Behavior Model	178
9.5. IviScopeWidthTrigger Compliance Notes	178

10.IviScopeAcLineTrigger Extension Group.....	179
10.1.IviScopeAcLineTrigger Overview	179
10.2.IviScopeAcLineTrigger Attributes	179
10.2.1.AC Line Trigger Slope	180
10.3.IviScopeAcLineTrigger Functions	183
10.3.1.Configure AC Line Trigger Slope (IVI-C only)	184
10.4.IviScopeAcLineTrigger Behavior Model	185
10.5.IviScopeAcLineTrigger Compliance Notes	185
11.IviScopeWaveformMeasurement Extension Group	186
11.1.IviScopeWaveformMeasurement Overview	186
11.2.IviScopeWaveformMeasurement Attributes	191
11.2.1.Measurement High Reference	192
11.2.2.Measurement Low Reference	194
11.2.3.Measurement Middle Reference	196
11.3.IviScopeWaveformMeasurement Functions	198
11.3.1.Configure Reference Levels	199
11.3.2.Fetch Waveform Measurement	200
11.3.3.Read Waveform Measurement	203
11.4.IviScopeWaveformMeasurement Behavior Model	208
12.IviScopeMinMaxWaveform Extension Group	209
12.1.IviScopeMinMaxWaveform Overview	209
12.2.IviScopeMinMaxWaveform Attributes	209
12.2.1.Number of Envelopes	210
12.3.IviScopeMinMaxWaveform Functions	211
12.3.1.Configure Number of Envelopes (IVI-C Only)	212
12.3.2.Fetch Min Max Waveform	213
12.3.3.Read Min Max Waveform	216
12.4.IviScopeMinMaxWaveform Behavior Model	221
12.5.IviScopeMinMaxWaveform Compliance Notes	221
13.IviScopeProbeAutoSense Extension Group	222
13.1.IviScopeProbeAutoSense Overview	222
13.2.IviScopeProbeAutoSense Attributes	222
13.2.1.Probe Attenuation Auto (IVI.NET Only)	223
13.2.2.Probe Sense Value (IVI-C & IVI-COM Only)	225
13.3.IviScopeProbeAutoSense Functions	227
13.3.1.Auto Probe Sense Value (IVI-C only)	228
13.4.IviScopeProbeAutoSense Behavior Model	229
13.5.IviScopeProbeAutoSense Compliance Notes	229
14.IviScopeContinuousAcquisition Extension Group	230
14.1.IviScopeContinuousAcquisition Overview	230
14.2.IviScopeContinuousAcquisition Attributes	230
14.2.1.Initiate Continuous	231
14.3.IviScopeContinuousAcquisition Functions	233
14.3.1.Configure Initiate Continuous (IVI-C only)	234
14.4.IviScopeContinuousAcquisition Behavior Model	235
15.IviScopeAverageAcquisition Extension Group	236
15.1.IviScopeAverageAcquisition Overview	236

15.2.IviScopeAverageAcquisition Attributes.....	236
15.2.1.Number of Averages.....	237
15.3.IviScopeAverageAcquisition Functions.....	239
15.3.1.Configure Number of Averages (IVI-C only).....	240
15.4.IviScopeAverageAcquisition Behavior Model.....	241
15.5.IviScopeAverageAcquisition Compliance Notes.....	241
16.IviScopeSampleMode Extension Group.....	242
16.1.IviScopeSampleMode Overview.....	242
16.2.IviScopeSampleMode Attributes.....	242
16.2.1.Sample Mode.....	243
16.3.IviScopeSampleMode Functions.....	245
16.3.1.Sample Mode (IVI-C only).....	246
16.4.IviScopeSampleMode Behavior Model.....	247
17.IviScopeTriggerModifier Extension Group.....	248
17.1.IviScopeTriggerModifier Overview.....	248
17.2.IviScopeTriggerModifier Attributes.....	248
17.2.1.Trigger Modifier.....	249
17.3.IviScopeTriggerModifier Functions.....	252
17.3.1.Configure Trigger Modifier (IVI-C only).....	253
17.4.IviScopeTriggerModifier Behavior Model.....	254
18.IviScopeAutoSetup Extension Group.....	255
18.1.IviScopeAutoSetup Overview.....	255
18.2.IviScopeAutoSetup Functions.....	255
18.2.1.Auto Setup.....	256
18.3.IviScopeAutoSetup Behavior Model.....	257
19.IviScope Attribute ID Definitions.....	258
19.1.IviScope Obsolete Attribute Names.....	259
19.2.IviScope Obsolete Attribute ID Values.....	259
20.IviScope Attribute Value Definitions.....	260
20.1.IviScope Obsolete Attribute Value Names.....	277
21.IviScope Function Parameter Value Definitions.....	278
21.1.IviScope Obsolete Function Parameter Value Names.....	283
22.IviScope Error and Completion Code Value Definitions.....	284
22.1.IVI.NET IviScope Exceptions and Warnings.....	285
22.1.1.ChannelNotEnabledException.....	286
22.1.2.InvalidAcquisitionTypeException.....	287
22.1.3.UnableToPerformMeasurementException.....	288
23.IviScope Hierarchies.....	289
23.1.IviScope .NET Hierarchy.....	289
23.1.1.IviScope .NET Interfaces.....	292

23.1.2. IviScope .NET Interface Reference Properties.....	292
23.2. IviScope COM Hierarchy.....	293
23.2.1. IviScope COM Interfaces.....	296
23.2.2. IviScope COM Interface Reference Properties.....	297
23.2.3. IviScope COM Category.....	297
23.3. IviScope C Function Hierarchy.....	297
23.3.1. IviScope Obsolete Function Names.....	300
23.4. IviScope C Attribute Hierarchy.....	301
A. Specific Driver Development Guidelines	304
1. Introduction.....	304
2. Disabling Unused Extensions.....	304
3. Query Instrument Status.....	306
4. Relationship of Acquisition Type and Horizontal Minimum Number of Points attributes.....	306
5. Auto-Setup and attribute invalidations.....	306
6. Suggestions for Implementing the Probe Attenuation Attribute	306
7. Attributes that use the Probe Attenuation attribute	307
8. Relationship of the Vertical Coupling and Trigger Coupling attributes.....	307
9. Instruments that have channel-based record lengths.....	307
10. Implementing the Trigger Holdoff attribute	307
B. Interchangeability Checking Rules.....	308
B.1 Introduction.....	308
B.2 When to Perform Interchangeability Checking	308
B.3 Interchangeability Checking Rules	308

IviScope Class Specification

IviScope Revision History

This section is an overview of the revision history of the IviScope specification.

Table 1. IviScope Class Specification Revisions

Revision Number	Date of Revision	Revision Notes
Revision 1.0	August 21, 1998	First Approved Version.
Revision 2.0b	July 20, 1999	Changes to the specification as the result of the Vendors' comments.
Revision 2.0c	September 01, 1999	Reformatted the document. Removed the Miscellaneous extension group and distributed the attributes in their own extension groups or in the base capability group. Renamed the Fundamental capability group to base capabilities group. Added the Interpolation extension group Added the AC Line triggering extension group Added the Probe auto-sense extension group Added the Continuous Acquisition extension group Added the Average extension group Added the Sample Mode extension group Added the Trigger Modifier extension group Added the Auto-setup extension group. Changed the compliance information for attributes and functions.
Revision 2.0d	October 7, 1999	Changed the actual value for the <code>IVISCOPE_VAL_NEGATIVE</code> from 2 to 0. Adjusted other values of attribute Ids and attribute value sets to maintain backwards compatibility for the drivers that were written to the 1.0 version of this specification. Removed Software Triggering.
Revision 2.0	November 22, 1999	Changed the Spec number to 2.0. Removed the "DRAFT" characterization—the specification has been approved.
Revision 3.0a	December 2000	Reformatted to adhere to IVI-3.4: Elements of Style for Class Specifications spec. Also specified the COM interface. Changed the specification number to 4.1.
Revision 3.0b	March 13, 2001	Implemented changes as agreed at the Feb 2001 IVICOM working group meeting.
Revision 2.1 (vc1)	July 1 st , 2001	Added appendices with C header and COM IDL file contents. Fixed miscellaneous typos and style issues.
Revision 2.1 (vc2)	August 31, 2001	Acted upon feedback from reviewers
Revision 2.1 (vc3)	December 18, 2001	Implemented changes as agreed at the December IVI Foundation Inc. meeting.

Table 1. IviScope Class Specification Revisions

Revision 2.1 (vc3.1)	December 27, 2001	Changed section references, corrected actual AttributeID for the channel count attribute, and removed the capability reference for the channel count properties.
Revision 3.0 (vc3.2)	January 21, 2002	Syntax check, formatting etc. Important change: removed the C description for ATTR_MEASUREMENT_CHANNEL_COUNT attribute since it is a COM –only property.
Revision 3.0 (vc3.3)	February 28, 2002	Final fixes to the IDL appendix, MaxTime parameter name change to MaxTimeMilliseconds, and changing the method prototypes to use LONG instead of IviScopeMaxTimeEnum for the MaxTimeMilliseconds parameter only. Added GUIDs for the IviScopeChannel and IviScopeMeasurement interfaces.
Revision 3.0	April 04, 2002	Specification has been approved – updated TOC, typelib version number, and updated COM UUIDs to release version.
Revision 3.0	February 14, 2003	Corrected a typo on page 95 (changed wording of ATTR_POLARITY to ATTR_RUNT_POLARITY)
Revision 3.0	October 01, 2004	Editorial change: Added the function prototype for the IviScope_GetChannelName function to the Appendix C: ANSI C Include file; this function exists in the specification (section 4.3.11) but was omitted from the appendix by mistake.
Revision 3.0	April 29, 2008	Editorial change to update the IVI Foundation contact information in the Important Information section to remove obsolete address information and refer only to the IVI Foundation web site.
Revision 3.0	April 2009	Editorial change to update repeated capabilities section to include both qualified and unqualified repeated capability names.
Revision 3.0	July 2009	Editorial change to revert the change in the IviScope_ConfigureNumberOfAverages C function prototype to original function name (IviScope_ConfigureNumAverages). Corrected a typo on page 142 (changed wording of Acquisition.NumEnvelopes to Acquisition.NumberOfEnvelopes)
Revision 4.0	June 9, 2010	Incorporated IVI.NET
Revision 4.1	February 11, 2011	Editorial change: Clarified which data type is for a specific interface type (Sections 4.2.1, 9.2.2, and 9.2.3)
Revision 4.1	August 25, 2011	Editorial IVI.NET change. Change references to process-wide locking to AppDomain-wide locking. Add an overload to the Create factory method that takes locking related parameters.
Revision 4.1	March10, 2012	Editorial IVI.NET change: Corrected a reference to 3.2 to correctly reference 3.18.

Table 1. IviScope Class Specification Revisions

Revision 4.1	September 24, 2015	Editorial Change – Clarified the use of one-based index for COM, and zero-based index for .NET for repeated capabilities in section 4.2.7.
Revision 4.1	October 14, 2016	Editorial Change – Modified header text for table 22.2 to indicate that the messages do not apply to .NET exceptions..

API Versions

Architecture	Drivers that comply with version 4.0 comply with all of the versions below
C	1.0, 3.0, 4.0
COM	3.0, 4.0
.NET	4.0

Drivers that comply with this version of the specification also comply with earlier, compatible, versions of the specification as shown in the table above. The driver may benefit by advertising that it supports all the API versions listed in the table above.

1. Overview of the IviScope Specification

1.1. Introduction

This specification defines the IVI class for oscilloscopes. The IviScope class is designed to support the typical oscilloscope as well as common extended functionality found in more complex instruments. This section summarizes the *IviScope Class Specification* itself and contains general information that the reader may need in order to understand, interpret, and implement aspects of this specification. These aspects include the following:

- IviScope Class Overview
- References
- The definitions of Terms and Acronyms

1.2. IviScope Class Overview

This specification defines the IVI class for oscilloscopes called IviScope. The IviScope class is designed to support the typical oscilloscope as well as common extended functionality found in more complex instruments. The IviScope class conceptualizes an oscilloscope as an instrument that can acquire time varying voltage waveforms.

The IviScope class is divided into the base capability group and extensions. The base capability group functions and attributes are used to configure an oscilloscope for typical waveform acquisition (this includes setting the channel, the acquisition, and the triggering sub-systems), initiating the waveform acquisition, and returning a waveform. The base capability group support only edge triggering and normal waveform acquisition. The IviScopeBase Capabilities are described in Section 4: *IviScopeBase Capability Group*.

In addition to the base capabilities, the IviScope class defines extended capabilities for oscilloscopes that can:

- Interpolate the points in the waveform record
- Have advanced triggering options such as TV, runt, glitch, width, and AC line
- Sense the probe attenuation
- Perform an auto-setup
- Use alternative acquisition modes such as average, envelope, and peak detect
- Use different sample modes such as real-time and equivalent
- Acquire data continuously
- Perform waveform measurements such as rise-time, fall-time, and voltage peak-to-peak

The IviScope extended capabilities are arranged into a set of extension capability groups.

1.3. References

The following documents and specifications are related to this specification:

- IVI-3.1: Driver Architecture Specification
- IVI-3.12: Floating Point Services Specification
- IVI-3.2: Inherent Capabilities Specification
- IVI-3.4: API Style Guide
- IVI-3.18: IVI.NET Utility Classes and Interfaces Specification
- IVI-5.0: Glossary

1.4. Definitions of Terms and Acronyms

Refer to *IVI-5.0: Glossary* for a description of the terms and acronyms used in this specification. This specification does not define any additional terms.

2.IviScope Class Capabilities

2.1.Introduction

The IviScope specification divides generic oscilloscope capabilities into a base capability group and multiple extension capability groups. Each capability group is discussed in a separate section. This section defines names for each capability group and gives an overview of the information presented for each capability group.

2.2.IviScope Group Names

The capability group names for the IviScope class are defined in the following table. The Group Name is used to represent a particular capability group and is returned as one of the possible group names from the Class Group Capabilities attribute.

Table 21. IviScope Group Names

Group Name	Description
IviScopeBase	Base Capabilities of the IviScope specification. This group includes the capability to acquire waveforms using edge triggering.
IviScopeInterpolation	Extension: IviScope with the ability to configure the oscilloscope to interpolate missing points in a waveform.
IviScopeTVTrigger	Extension: IviScope with the ability to trigger on standard television signals.
IviScopeRuntTrigger	Extension: IviScope with the ability to trigger on runts.
IviScopeGlitchTrigger	Extension: IviScope with the ability to trigger on glitches.
IviScopeWidthTrigger	Extension: IviScope with the ability to trigger on a variety of conditions regarding pulse widths.
IviScopeAcLineTrigger	Extension: IviScope with the ability to trigger on zero crossings of a network supply voltage.
IviScopeWaveformMeas	Extension: IviScope with the ability to calculate waveform measurements, such as rise time or frequency.
IviScopeMinMaxWaveform	Extension: IviScope with the ability to acquire a minimum and maximum waveforms that correspond to the same time range.
IviScopeProbeAutoSense	Extension: IviScope with the ability to automatically sense the probe attenuation of an attached probe.
IviScopeContinuous Acquisition	Extension: IviScope with the ability to continuously acquire data from the input and display it on the screen.
IviScopeAverage Acquisition	Extension: IviScope with the ability to create a waveform that is the average of multiple waveform acquisitions.
IviScopeSampleMode	Extension: IviScope with the ability to return the actual sample mode.
IviScopeTrigger Modifier	Extension: IviScope with the ability to modify the behavior of the triggering subsystem in the absence of a expected trigger.
IviScopeAutoSetup	Extension: IviScope with the automatic configuration ability.

Refer to Section 16, *Class Specification Layout*, in *IVI-3.4: API Style Guide* for a description of the Capability Group Section Layout.

2.3.Repeated Capability Names

The IviScope Class Specification defines one repeated capability. Refer to the sections of *IVI-3.1, Driver Architecture Specification* that deal with repeated capabilities. The relevant sections are Section 2.7, *Repeated Capabilities*, Section 4.1.9, *Repeated Capabilities*, Section 4.2.5, *Repeated Capabilities*, Section 4.3.9, *Repeated Capabilities*, and Section 5.9, *Repeated Capability Identifiers and Selectors*.

- Channel

2.3.1.Channel

In the configuration store, the name for the channel repeated capability shall be exactly one of “Channel” or “IviScopeChannel”. Drivers that implement multiple repeated capabilities with the name “channel” shall use the latter form to disambiguate the names.

In IVI.NET, there is no measurement collection for per-channel measurements that is separate from the Channel collection. Instead, the per-channel measurement Fetch and Read methods are in a Measurement interface (IIviScopeChannelMeasurement) that is referenced from the per-channel interface (IIviScopeChannel). Measurement methods and properties that are not per-channel are in a Measurement interface (IIviScopeMeasurement) that is referenced from the base interface (IIviScope).

2.4.Boolean Attribute and Parameter Values

This specification uses True and False as the values for Boolean attributes and parameters. The following table defines the identifiers that are used for True and False in the IVI.NET, IVI-COM, and IVI-C architectures.

Boolean Value	IVI.NET Identifier	IVI-COM Identifier	IVI-C Identifier
True	true	VARIANT_TRUE	VI_TRUE
False	false	VARIANT_FALSE	VI_FALSE

2.5..NET Namespace

The .NET namespace for the IviScope class is `Ivi.Scope`.

2.6..NET IviScope Session Factory

The IviScope .NET assembly contains a factory method called Create for creating instances of IviScope class-compliant IVI.NET drivers from driver sessions and logical names. Create is a static method accessible from the static IviScope class.

Refer to *IVI-3.5: Configuration Server Specification* for a description of how logical names and session names are defined in the configuration store.

Refer to Section 8, *IVI.NET Specific Driver Constructor*, of *IVI-3.2: Inherent Capabilities Specification*, for more details on how the `idQuery`, `reset`, and `options` parameters affect the instantiation of the driver.

Refer to Section 4.3.11, *Multithread Safety*, of *IVI-3.1: Driver Architecture Specification* for a complete description of IVI.NET driver locking. Refer to Section 8, Table 8.2 *Required Lock Type Behavior for Drivers With the Same Access Key*, of *IVI-3.2, Inherent Capability Specification*, for an explanation of how the values for `lockType` and `accessKey` are used to determine the kind of multithreaded lock to use for the driver instance.

.NET Method Prototype

```
IIviScope Ivi.Scope.Create(String name);  
IIviScope Ivi.Scope.Create(String name,  
                             Boolean idQuery,  
                             Boolean reset);  
IIviScope Ivi.Scope.Create(String name,  
                             Boolean idQuery,  
                             Boolean reset,  
                             String options);  
IIviScope Ivi.Scope.Create(String resourceName,  
                             Boolean idQuery,  
                             Boolean reset,  
                             LockType lockType,  
                             String accessKey,  
                             String options);
```

Parameters

Inputs	Description	Base Type
name	A session name or a logical name that points to a session that uses an IVI.NET IviScope class-compliant driver.	String
idQuery	Specifies whether to verify the ID of the instrument. The default is False.	Boolean
reset	Specifies whether to reset the instrument. The default is False.	Boolean
lockType	Specifies whether to use AppDomain-wide locking or machine-wide locking.	Ivi.Driver.LockType
accessKey	Specifies a user-selectable access key to identify the lock. Driver instances that are created with the same accessKey will be protected from simultaneous access by multiple threads within an AppDomain or across AppDomains, depending upon the value of the lockType parameter.	String
options	A string that allows the user to specify the initial values of certain inherent attributes. The default is an empty string.	String

Outputs	Description	Base Type
Return Value	Interface pointer to the IviScope interface of the driver referenced by session.	IviScope

Defined Values

Name	Description	
	Language	Identifier
AppDomain	The lock is AppDomain-wide.	
	.NET	Ivi.Driver.LockType.AppDomain
Machine	The lock is machine-wide.	
	.NET	Ivi.Driver.LockType.Machine

.NET Exceptions

The *IVI-3.2: Inherent Capabilities Specification* defines general exceptions that may be thrown, and warning events that may be raised, by this method.

Usage

To create a driver that implements the IviScope instrument class API from the logical name “My LogicalName”, use the following code:

```
IIVI_Scope scope = IIVI_Scope.Create("MyLogicalName");
```

In this case, the ID of the instrument will not be verified, the instrument will not be reset, and options will be supplied from the configuration store and/or driver defaults.

3.General Requirements

This section describes the general requirements a specific instrument driver must meet in order to be compliant with this specification. In addition, it provides general requirements that IVI Class-Compliant specific drivers must meet in order to comply with a capability group, attribute, or function.

3.1.Minimum Class Compliance

To be compliant with the IviScope Class Specification, an IVI specific driver shall conform to all of the requirements for an IVI class-compliant specific driver as specified in *IVI-3.1: Driver Architecture Specification*, implement the inherent capabilities that *IVI- 3.2: Inherent IVI Capabilities Specification* defines, and implement the IviScopeBase capability group.

3.1.1.Disable

Refer to *IVI-3.2: Inherent Capabilities Specification* for the prototype of this function. The IviScope specification does not define additional requirements on the Disable function.

3.2.Capability Group Compliance

IVI-3.1: Driver Architecture Specification defines the general rules for an IVI Class-Compliant specific driver to be compliant with a capability group.

4.IviScopeBase Capability Group

4.1.Overview

The IviScope base capabilities support oscilloscopes that can acquire waveforms from multiple channels with an edge trigger. The IviScope base capabilities define attributes and their values to configure the oscilloscope's channel, acquisition, and trigger sub-systems. The IviScope base capabilities also include functions for configuring the oscilloscope as well as initiating waveform acquisition and retrieving waveforms.

The IviScope base capabilities organize the configurable settings into three main categories: the channel sub-system, the acquisition sub-system, and the trigger sub-system.

4.1.1.Channel Sub-System

The channel sub-system configures the range of voltages the oscilloscope acquires and how the oscilloscope couples the input signal to the acquisition sub-system. The main channel sub-system attributes include:

- Channel Enabled
- Probe Attenuation
- Vertical Coupling
- Vertical Offset
- Vertical Range

All of the channel sub-system attributes represent a capability that is repeated on all instrument's channels. They can be set as a group with the Configure Channel function.

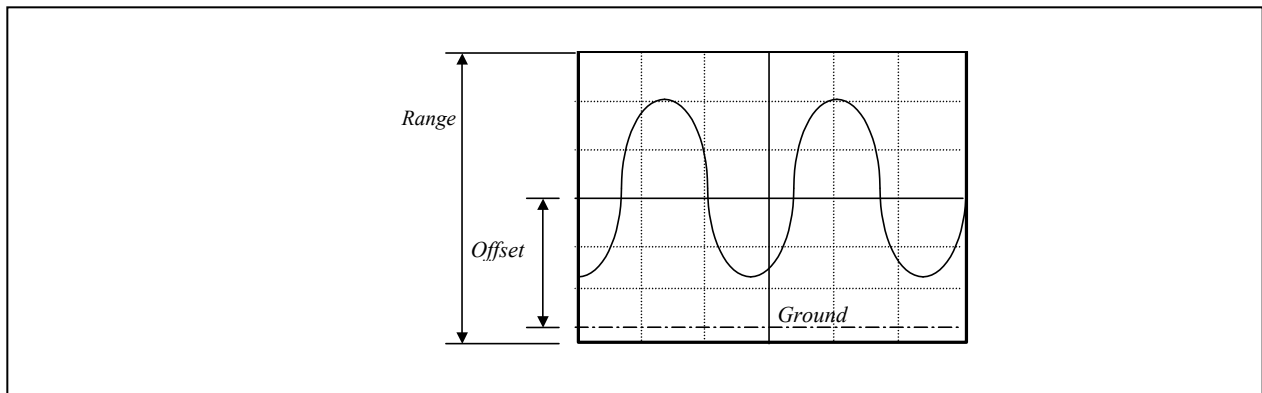

Figure 4-1. Channel Sub-System Attributes

The Vertical Range attribute specifies the absolute value of the range of voltages that the oscilloscope acquires. The Vertical Offset attribute specifies the center of the range specified by the Vertical Range attribute with respect to ground. The Vertical Coupling attribute specifies how to couple the input signal to the channel sub-system. The Probe Attenuation attribute specifies the scaling factor by which the probe attenuates the input signal. Typically, the value of the Probe Attenuation attribute determines the range values the driver accepts for the Vertical Range and Vertical Offset attributes. The Channel Enabled attribute specifies whether the oscilloscope acquires a waveform for the channel.

4.1.2.Acquisition Sub-System

The acquisition sub-system configures the acquisition type, the size of the waveform record, the length of time that corresponds to the overall waveform record, and the position of the first point in the waveform record relative to the Trigger Event. The configurable Acquisition sub-system attributes include:

- Acquisition Start Time

- Acquisition Type
- Horizontal Minimum Number of Points
- Horizontal Time Per Record

The end-user specifies how the oscilloscope acquires the data and fills the waveform record with the Acquisition Type attribute. The user specifies the minimum number of points they require the oscilloscope to acquire with the Horizontal Minimum Number of Points attribute. The Horizontal Time Per Record attribute specifies the length of time that corresponds to the overall waveform record. The Acquisition Start Time attribute specifies the position of the first point in the waveform record relative to the Trigger Event. If the value is positive, the first point in the waveform record occurs *after* the trigger event. If the value is negative, the first point in the waveform record occurs *before* the trigger event. The Figure 4-2 shows the effect of the negative acquisition start time value.

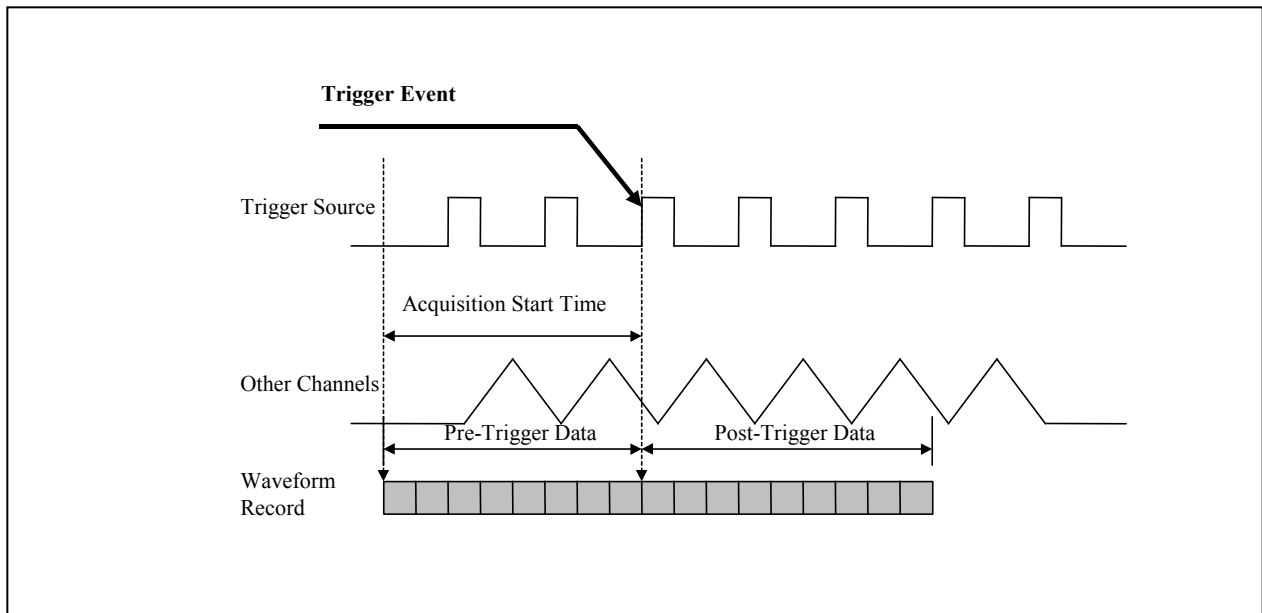

Figure 4-2. Acquisition Overview

Acquisition attributes can be set as a group with the Configure Acquisition Type (IVI-C only) and Configure Acquisition Record functions.

In addition, the acquisition sub-system includes two read-only attributes:

- Horizontal Record Length
- Horizontal Sample Rate

The Horizontal Record Length attribute returns the actual number of points in the waveform record. The Horizontal Sample Rate attribute returns the effective sample rate of the oscilloscope.

The IviScope class defines separate attributes for the minimum record size that the end-user requests and the actual record length. Typically, oscilloscopes change the record length dynamically when the acquisition type changes. For example, when the end-user changes the acquisition type from normal to envelope, many oscilloscopes reduce the record length by half. When the end-user initiates a waveform acquisition, the instrument driver uses the value held in the Horizontal Minimum Number of Points attribute to check that the new record length is equal to or greater than the minimum record length the enduser requires.

4.1.3. Trigger Sub-System

The trigger sub-system configures the type of event that triggers the oscilloscope. The global trigger sub-system attributes are:

- Trigger Coupling
- Trigger Holdoff
- Trigger Type

The Trigger Type attribute specifies the event that triggers the oscilloscope.

The Trigger Holdoff attribute specifies the length of time after the oscilloscope detects a trigger during which the oscilloscope ignores additional triggers. The Trigger Holdoff attribute affects the instrument operation only when the oscilloscope requires multiple acquisitions to build a complete waveform. The oscilloscope requires multiple waveform acquisitions when the sample mode is equivalent time or the acquisition type is set to envelope or average.

The Trigger Coupling attribute specifies how the oscilloscope couples the trigger source to the trigger sub-system.

The attributes from the above list can be set as a group with the Configure Trigger and Configure Trigger Coupling (IVI-C only) functions.

The following attributes configure the edge trigger. These attributes can be set as a group with the Configure Edge Trigger Source function.

- Trigger Level
- Trigger Source
- Trigger Slope

The Trigger Level attribute specifies the voltage threshold for the trigger sub-system. The Trigger Source attribute specifies the source the oscilloscope monitors for the trigger event. Most of the trigger types use the values held in the Trigger Level and Trigger Source attributes.

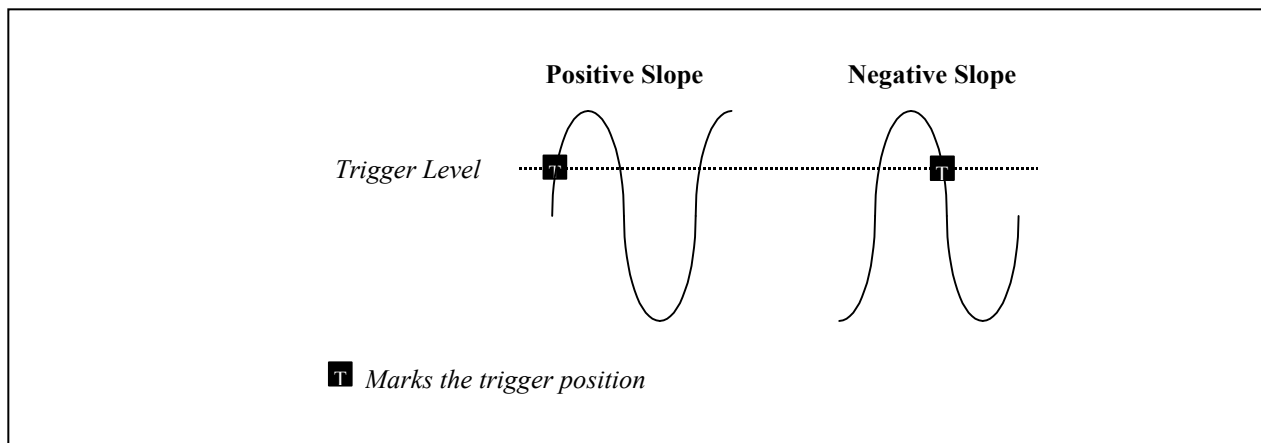

Figure 4-3. Edge Triggers

The Trigger Slope attribute specifies whether a positive or negative edge triggers the oscilloscope.

When the trigger type is edge, the values held in the Trigger Level, Trigger Source, and Trigger Slope attributes define the trigger event. The oscilloscope triggers when the signal from the trigger source crosses the threshold level with the polarity that the Trigger Level and Trigger Coupling attributes specify.

The following figure shows how the hold-off affects the trigger sub-system. Ideally the trigger event occurs at condition '1', but sometimes the oscilloscope triggers on condition '2' because the signal crosses the

trigger level. When the end-user specifies an appropriate hold-off, the oscilloscope triggers on conditions '1' and '3', and ignores conditions '2' and '4'.

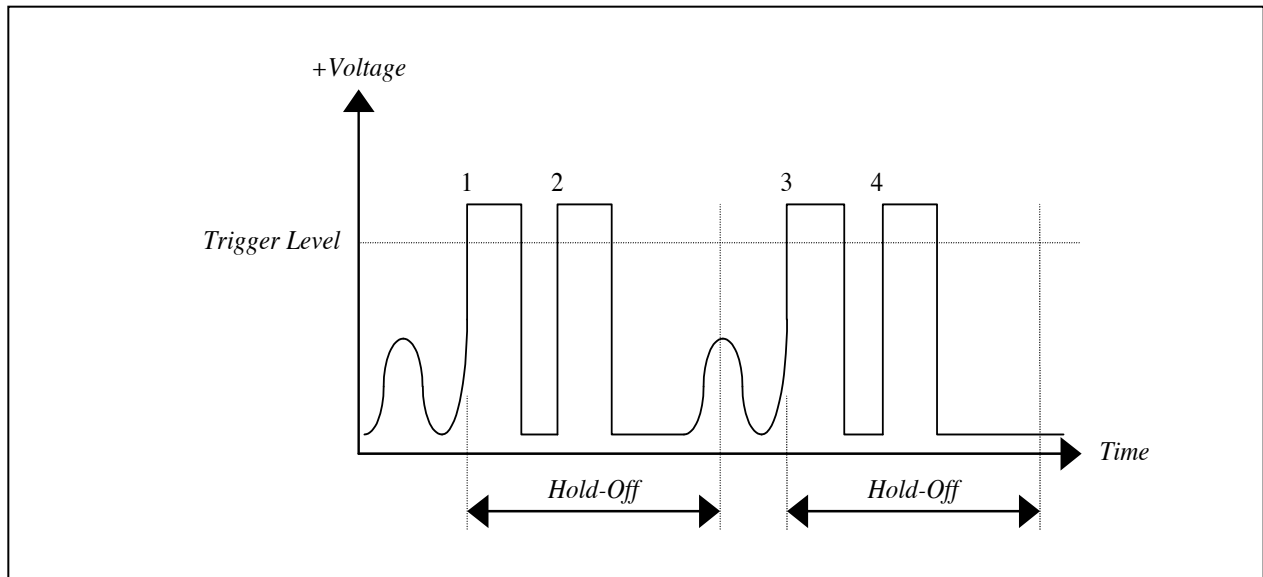

Figure 4-4. Trigger Hold-Off Overview

This IviScopeBase Capabilities define functions that retrieve waveforms from the oscilloscope. These functions return the following information:

- The waveform record as an array of voltages.
- The time that corresponds to the first point in the waveform array relative to the Trigger Event (acquisition start time).
- The effective time between points in the waveform record.

4.2. IviScopeBase Attributes

The IviScopeBase capability group defines the following attributes:

- Acquisition Start Time
- Acquisition Status (IVI.NET Only)
- Acquisition Type
- Channel Count
- Channel Enabled
- Channel Item (IVI-COM & IVI.NET only)
- Channel Name (IVI-COM & IVI.NET only)
- Horizontal Minimum Number of Points
- Horizontal Record Length
- Horizontal Sample Rate
- Horizontal Time Per Record
- Input Impedance
- Maximum Input Frequency
- Measurement Channel Count (IVI-COM Only)
- Measurement Channel Item (IVI-COM Only)
- Probe Attenuation
- Trigger Coupling
- Trigger Holdoff
- Trigger Level
- Trigger Slope
- Trigger Source
- Trigger Type
- Vertical Coupling
- Vertical Offset
- Vertical Range

This section describes the behavior and requirements of each attribute. The actual value for each attribute ID is defined in Section 19, *IviScope Attribute ID Definitions*.

4.2.1.Acquisition Start Time

Data Type	Access	Applies to	Coercion	High Level Functions
ViReal64 (C/COM)	R/W	N/A	None	Configure Acquisition Record
Ivi.Driver.PrecisionTimeSpan (.NET)	R/W	N/A	None	Configure Acquisition Record

.NET Property Name

Acquisition.StartTime

COM Property Name

Acquisition.StartTime

C Constant Name

IVISCOPE_ATTR_ACQUISITION_START_TIME

Description

Specifies the length of time from the trigger event to the first point in the waveform record. If the value is positive, the first point in the waveform record occurs *after* the trigger event. If the value is negative, the first point in the waveform record occurs *before* the trigger event. For C and COM, the units are seconds. For IVI.NET, the units are implicit in the definition of PrecisionTimeSpan.

.NET Exceptions

The *IVI-3.2: Inherent Capabilities Specification* defines general exceptions that may be thrown, and warning events that may be raised, by this property.

4.2.2.Acquisition Status (IVI.NET Only)

Data Type	Access	Applies to	Coercion	High Level Functions
AcquisitionStatus	R/O	Measurement	None	N/A

.NET Property Name

Measurement.Status;

.NET Enumeration Name

AcquisitionStatus;

COM Property Name

N/A
See the Acquisition Status Method.

C Constant Name

N/A
See the Acquisition Status Method.

Description

Acquisition status indicates whether an acquisition is in progress, complete, or if the status is unknown.

Acquisition status is not the same as instrument status, and does not necessarily check for instrument errors. To make sure that the instrument is checked for errors after getting the acquisition status, call the Error Query method. (Note that the end user may want to call Error Query at the end of a sequence of other calls which include getting the acquisition status, - it does not necessarily need to be called immediately.)

If the driver cannot determine whether the acquisition is complete or not, it returns the Acquisition Status Unknown value.

Defined Values

<i>Name</i>	<i>Description</i>	
	<i>Language</i>	<i>Identifier</i>
Acquisition Complete	The oscilloscope has completed the acquisition.	
	.NET	AcquisitionStatus.Complete
Acquisition In Progress	The oscilloscope is still acquiring data.	
	.NET	AcquisitionStatus.InProgress
Acquisition Status Unknown	The oscilloscope cannot determine the status of the acquisition.	
	.NET	AcquisitionStatus.Unknown

.NET Exceptions

The *IVI-3.2: Inherent Capabilities Specification* defines general exceptions that may be thrown, and warning events that may be raised, by this property.

4.2.3.Acquisition Type

Data Type	Access	Applies to	Coercion	High Level Functions
ViInt32	R/W	N/A	None	Configure Acquisition Type (IVI-C only)

.NET Property Name

Acquisition.Type

.NET Enumeration Name

AcquisitionType

COM Property Name

Acquisition.Type

COM Enumeration Name

IviScopeAcquisitionTypeEnum

C Constant Name

IVISCOPE_ATTR_ACQUISITION_TYPE

Description

Specifies how the oscilloscope acquires data and fills the waveform record.

Defined Values

<i>Name</i>	<i>Description</i>	
	<i>Language</i>	<i>Identifier</i>
Normal	Configures the oscilloscope to acquire one sample for each point in the waveform record. The oscilloscope uses real-time or equivalent time sampling.	
	.NET	AcquisitionType.Normal
	C	IVISCOPE_VAL_NORMAL
	COM	IviScopeAcquisitionTypeNormal
High Resolution	Configures the oscilloscope to oversample the input signal. The oscilloscope calculates the average value that corresponds to each position in the waveform record. The oscilloscope uses only real-time sampling.	
	.NET	AcquisitionType.HiResolution
	C	IVISCOPE_VAL_HI_RES
	COM	IviScopeAcquisitionTypeHiRes
Average	Configures the oscilloscope to acquire multiple waveforms and calculate the average value for each point in the waveform record. The end-user specifies the number of waveforms to acquire with the Number of Averages attribute. The oscilloscope uses real-time or equivalent time sampling.	
	.NET	AcquisitionType.Average
	C	IVISCOPE_VAL_AVERAGE
	COM	IviScopeAcquisitionTypeAverage
Peak Detect	Sets the oscilloscope to the peak-detect acquisition mode. The oscilloscope oversamples the input signal and keeps the minimum and maximum values that correspond to each position in the waveform record. The oscilloscope uses only real-time sampling.	
	.NET	AcquisitionType.PeakDetect
	C	IVISCOPE_VAL_PEAK_DETECT
	COM	IviScopeAcquisitionTypePeakDetect
Envelope	Sets the oscilloscope to the envelope acquisition mode. The oscilloscope acquires multiple waveforms and keeps the minimum and maximum voltages it acquires for each point in the waveform record. The end-user specifies the number of waveforms the oscilloscope acquires with the Number of Envelopes attribute. The oscilloscope can use real-time or equivalent-time sampling.	
	.NET	AcquisitionType.Envelope
	C	IVISCOPE_VAL_ENVELOPE
	COM	IviScopeAcquisitionTypeEnvelope

.NET Exceptions

The *IVI-3.2: Inherent Capabilities Specification* defines general exceptions that may be thrown, and warning events that may be raised, by this property.

Compliance Notes

1. The driver shall implement the Normal value for this attribute.
2. If an IVI-C class driver defines additional values for this attribute, the actual values shall be greater than or equal to `IVISCOPE_VAL_ACQUISITION_TYPE_CLASS_EXT_BASE` and less than `IVISCOPE_VAL_ACQUISITION_TYPE_SPECIFIC_EXT_BASE`.
3. If an IVI-C specific driver defines additional values for this attribute, the actual values shall be greater than or equal to `IVISCOPE_VAL_ACQUISITION_TYPE_SPECIFIC_EXT_BASE`.
4. If an IVI Class-Compliant specific driver implements any of the defined values in the following table, it shall also implement the corresponding capability group:

Value	Required Capability Group
Peak Detect	IviScopeMinMaxWaveform
Envelope	IviScopeMinMaxWaveform
Average	IviScopeAverageAcquisition

5. If an IVI-COM specific driver implements this attribute with additional elements in its instrument specific interfaces, the actual values of the additional elements shall be greater than or equal to Acquisition Type Specific Ext Base.

See Section 20, *IviScope Attribute Value Definitions*, for the definitions of Acquisition Type Specific Ext Base, `IVISCOPE_VAL_ACQUISITION_TYPE_SPECIFIC_EXT_BASE` and `IVISCOPE_VAL_ACQUISITION_TYPE_CLASS_EXT_BASE`.

4.2.4.Channel Count

Data Type	Access	Applies to	Coercion	High Level Functions
ViInt32	RO	Channel	None	None

.NET Property Name

`Channels.Count`

This property is inherited from `IIviRepeatedCapabilityCollection`.

COM Property Name

`Channels.Count`

C Constant Name

`IVISCOPE_ATTR_CHANNEL_COUNT`

Description

Returns the number of currently available channels. The count returned includes any of the supported reserved repeated capability names defined in Section 2.3, *Repeated Capability Names* as well as any custom repeated capability identifiers.

.NET Exceptions

The *IVI-3.2: Inherent Capabilities Specification* defines general exceptions that may be thrown, and warning events that may be raised, by this property.

4.2.5.Channel Enabled

Data Type	Access	Applies to	Coercion	High Level Functions
ViBoolean	R/W	Channel	None	Configure Channel

.NET Property Name

`Channels[].Enabled`

COM Property Name

`Channels.Item().Enabled`

C Constant Name

`IVISCOPE_ATTR_CHANNEL_ENABLED`

Description

If set to True, the oscilloscope acquires a waveform for the channel. If set to False, the oscilloscope does not acquire a waveform for the channel.

Compliance Notes

Instrument drivers shall support the value True.

.NET Exceptions

The *IVI-3.2: Inherent Capabilities Specification* defines general exceptions that may be thrown, and warning events that may be raised, by this property.

4.2.6.Channel Item (IVI-COM & IVI.NET Only)

Data Type	Access	Applies to	Coercion	High Level Functions
IIviScopeChannel*	RO	Channel	None	None

.NET Property Name

Channels[String name]

This indexer is inherited from `IIVIRepeatedCapabilityCollection`. The name parameter uniquely identifies a particular channel in the Channels collection.

COM Property Name

Channels.Item ([in] BSTR Name);

C Constant Name

N/A

Description

Channel Item uniquely identifies a channel in the channels collection. It returns an interface pointer which can be used to control the attributes and other functionality of that channel.

The Item property takes a channel name. If the user passes an invalid value for the `ChannelName` parameter, the property returns an error.

Valid Names include physical repeated capability identifiers and virtual repeated capability identifiers.

Parameters

Inputs	Description	Datatype
name (.NET) Name (COM)	Specifies the name of the channel to retrieve.	ViConstString

Return Values (C/COM)

If the IVI-COM driver cannot recognize the `Name` parameter, it returns an Unknown Name in Selector completion code as described in *IVI-3.2: Inherent Capabilities Specification*, Section 9.3.

.NET Exceptions

The *IVI-3.2: Inherent Capabilities Specification* defines general exceptions that may be thrown, and warning events that may be raised, by this property.

4.2.7.Channel Name (IVI-COM & IVI.NET Only)

Data Type	Access	Applies to	Coercion	High Level Functions
ViString	RO	Channel	None	None

.NET Property Name

`Channels[].Name`

This property is inherited from `IIviRepeatedCapabilityIdentification`.

COM Property Name

`Channels.Name ([in] LONG Index);`

and

`Measurements.Name ([in] LONG Index);`

C Constant Name

N/A.

(Use the `GetChannelName` function.)

Description

Returns the physical repeated capability identifier defined by the specific driver for the channel that corresponds to the index that the user specifies. If the driver defines a qualified channel name, this property returns the qualified name.

In COM, the index is one-based. In .NET, the index is zero-based.

For C and COM, valid values for the `ChannelIndex` parameter are between one and the value of the `Channel Count` attribute, inclusive. If the user passes an invalid value for the `ChannelIndex` parameter, the value of this attribute is an empty string.

.NET Exceptions

The *IVI-3.2: Inherent Capabilities Specification* defines general exceptions that may be thrown, and warning events that may be raised, by this property.

4.2.8. Horizontal Minimum Number of Points

Data Type	Access	Applies to	Coercion	High Level Functions
ViInt32	R/W	N/A	None	Configure Acquisition Record

.NET Property Name

`Acquisition.NumberOfPointsMinimum`

COM Property Name

`Acquisition.NumberOfPointsMin`

C Constant Name

`IVISCOPE_ATTR_HORZ_MIN_NUM_PTS`

Description

Specifies the minimum number of points the end-user requires in the waveform record for each channel. The instrument driver uses the value the end-user specifies to configure the record length that the oscilloscope uses for waveform acquisition. If the instrument cannot support the requested record length, the driver shall configure the instrument to the closest bigger record length. The Horizontal Record Length attribute returns the actual record length.

.NET Exceptions

The *IVI-3.2: Inherent Capabilities Specification* defines general exceptions that may be thrown, and warning events that may be raised, by this property.

4.2.9. Horizontal Record Length

Data Type	Access	Applies to	Coercion	High Level Functions
ViInt32	RO	N/A	N/A	Actual Record Length (IVI-C only)

.NET Property Name

Acquisition.RecordLength

COM Property Name

Acquisition.RecordLength

C Constant Name

IVISCOPE_ATTR_HORZ_RECORD_LENGTH

Description

Returns the actual number of points the oscilloscope acquires for each channel. The value is equal to or greater than the minimum number of points the end-user specifies with the Horizontal Minimum Number of Points attribute.

Note: Oscilloscopes may use different size records depending on the value the user specifies for the Acquisition Type attribute.

.NET Exceptions

The *IVI-3.2: Inherent Capabilities Specification* defines general exceptions that may be thrown, and warning events that may be raised, by this property.

4.2.10. Horizontal Sample Rate

Data Type	Access	Applies to	Coercion	High Level Functions
ViReal64	RO	N/A	N/A	Sample Rate (IVI-C only)

.NET Property Name

`Acquisition.SampleRate`

COM Property Name

`Acquisition.SampleRate`

C Constant Name

`IVISCOPE_ATTR_HORZ_SAMPLE_RATE`

Description

Returns the effective sample rate of the acquired waveform using the current configuration. The units are samples per second.

.NET Exceptions

The *IVI-3.2: Inherent Capabilities Specification* defines general exceptions that may be thrown, and warning events that may be raised, by this property.

4.2.11. Horizontal Time Per Record

Data Type	Access	Applies to	Coercion	High Level Functions
ViReal64 (C/COM)	R/W	N/A	Up	Configure Acquisition Record
Ivi.Driver.PrecisionTimeSpan (.NET)	R/W	N/A	Up	Configure Acquisition Record

.NET Property Name

Acquisition.TimePerRecord

COM Property Name

Acquisition.TimePerRecord

C Constant Name

IVISCOPE_ATTR_HORZ_TIME_PER_RECORD

Description

Specifies the length of time that corresponds to the record length. For C and COM, the units are seconds. For IVI.NET, the units are implicit in the definition of PrecisionTimeSpan.

.NET Exceptions

The *IVI-3.2: Inherent Capabilities Specification* defines general exceptions that may be thrown, and warning events that may be raised, by this property.

4.2.12. Input Impedance

Data Type	Access	Applies to	Coercion	High Level Functions
ViReal64	R/W	Channel	None	Configure Channel Characteristics

.NET Property Name

`Channels[].InputImpedance`

COM Property Name

`Channels.Item().InputImpedance`

C Constant Name

`IVISCOPE_ATTR_INPUT_IMPEDANCE`

Description

Specifies the input impedance for the channel in Ohms.

Common values are 50.0, 75.0, and 1,000,000.0.

.NET Exceptions

The *IVI-3.2: Inherent Capabilities Specification* defines general exceptions that may be thrown, and warning events that may be raised, by this property.

4.2.13. Maximum Input Frequency

Data Type	Access	Applies to	Coercion	High Level Functions
ViReal64	R/W	Channel	Up	Configure Channel Characteristics

.NET Property Name

`Channels[].InputFrequencyMaximum`

COM Property Name

`Channels.Item().InputFrequencyMax`

C Constant Name

`IVISCOPE_ATTR_MAX_INPUT_FREQUENCY`

Description

Specifies the maximum frequency for the input signal you want the instrument to accommodate without attenuating it by more than 3dB. If the bandwidth limit frequency of the instrument is greater than this maximum frequency, the driver enables the bandwidth limit. This attenuates the input signal by at least 3dB at frequencies greater than the bandwidth limit.

.NET Exceptions

The *IVI-3.2: Inherent Capabilities Specification* defines general exceptions that may be thrown, and warning events that may be raised, by this property.

4.2.14. Measurement Channel Count (IVI-COM Only)

Data Type	Access	Applies to	Coercion	High Level Functions
ViInt32	RO	Measurement	None	None

.NET Property Name

N/A

The measurement interface is accessed via an interface reference property in the IviScope interface. The channel measurement interface is accessed via an interface reference property in the Channel interface.

COM Property Name

Measurements.Count

C Constant Name

N/A

Description

Returns the number of available measurement channels. The count returned includes any of the supported reserved repeated capability names defined in Section 2.1.6, *Reserved Repeated Capability Identifiers* as well as any custom repeated capability identifiers.

4.2.15. Measurement Channel Item (IVI-COM Only)

Data Type	Access	Applies to	Coercion	High Level Functions
IIviScopeMeasurement*	RO	Measurement	None	None

.NET Property Name

N/A

The measurement interface is accessed via an interface reference property in the IviScope interface. The channel measurement interface is accessed via an interface reference property in the Channel interface. See section 2.3.1, *Channel*, for more details.

COM Property Name

Measurements.Item ([in] BSTR Name);

C Constant Name

N/A

Description

Measurement Channel Item uniquely identifies a measurement channel in the measurements collection. It returns an interface reference to the IIviScopeMeasurement interface which can be used to control the attributes and other functionality of that measurement channel.

Valid Names include physical repeated capability identifiers and virtual repeated capability identifiers.”

Parameters

Inputs	Description	Datatype
Name	Specifies the name of the channel to retrieve.	ViConstString

Return Values

If the IVI-COM driver cannot recognize the Name parameter, it returns an Unknown Name in Selector completion code as described in *IVI-3.2: Inherent Capabilities Specification*, Section 9.3.

4.2.16. Probe Attenuation

Data Type	Access	Applies to	Coercion	High Level Functions
ViReal64	R/W	Channel	None	Configure Channel

.NET Property Name

`Channels[].ProbeAttenuation`

COM Property Name

`Channels.Item().ProbeAttenuation`

C Constant Name

`IVISCOPE_ATTR_PROBE_ATTENUATION`

Description

Specifies the scaling factor by which the probe the end-user attaches to the channel attenuates the input. For example, for a 10:1 probe, the end-user sets this attribute to 10.0.

Note that if the probe is changed to one with a different attenuation, and this attribute is not set, the amplitude calculations will be incorrect.

The behavior is different for IVI-C/IVI-COM and IVI.NET as follows:

- IVI-C/IVI-COM Specifies the measurement range. Positive values represent the absolute value of the maximum measurement expected. The specific driver is expected to coerce this value to the appropriate range for the instrument. Negative values represent the Auto Range mode.
- IVI.NET Specifies the probe attenuation. Querying this value will return the probe attenuation corresponding to the instrument's actual probe attenuation. Setting this property sets Probe Attenuation Auto to False. Negative values are not valid.

The *IviScopeProbeAutoSense* extension section defines the Probe Attenuation Auto attribute.

Defined Values

<i>Name</i>	<i>Description</i>	
	<i>Language</i>	<i>Identifier</i>
Probe Sense On (C/COM Only)	Configures the oscilloscope to sense the attenuation of the probe automatically. After the end-user enables the automatic probe sense, subsequent queries of this attribute return the value Probe Sense On. Use the Probe Sense Value attribute to obtain the actual probe attenuation. If the oscilloscope is set to sense the probe attenuation automatically, setting this attribute to a value different from Probe Sense On disables the automatic probe sense and configures the oscilloscope to use the manual probe attenuation the end-user specifies.	
	C	IVISCOPE_VAL_PROBE_SENSE_ON
	COM	-1.0

.NET Exceptions

The *IVI-3.2: Inherent Capabilities Specification* defines general exceptions that may be thrown, and warning events that may be raised, by this property.

Compliance Notes

1. If an IVI-C class driver defines additional values for this attribute, the actual values shall be less than or equal to `IVISCOPE_VAL_PROBE_ATTENUATION_CLASS_EXT_BASE` and greater than `IVISCOPE_VAL_PROBE_ATTENUATION_SPECIFIC_EXT_BASE`.
2. If an IVI-C specific driver defines additional values for this attribute, the actual values shall be less than or equal to `IVISCOPE_VAL_PROBE_ATTENUATION_SPECIFIC_EXT_BASE`.
3. If an IVI-C or IVI-COM Class Compliant specific driver implements any of the defined values in the following table, it shall also implement the corresponding capability group:

Value	Required Capability Group
Probe Sense On	IviScopeProbeAutoSense

4. If an IVI-COM specific driver implements this attribute with additional elements in its instrument specific interfaces, the actual values of the additional elements shall be greater than or equal to Probe Attenuation Specific Ext Base.

See Section 20, *IviScope Attribute Value Definitions*, for the definitions of Probe Attenuation Specific Ext Base, `IVISCOPE_VAL_PROBE_ATTENUATION_SPECIFIC_EXT_BASE` and `IVISCOPE_VAL_PROBE_ATTENUATION_CLASS_EXT_BASE`.

4.2.17. Trigger Coupling

Data Type	Access	Applies to	Coercion	High Level Functions
ViInt32	R/W	N/A	None	Configure Trigger Coupling (IVI-C only)

.NET Property Name

`Trigger.Coupling`

.NET Enumeration Name

`TriggerCoupling`

COM Property Name

`Trigger.Coupling`

COM Enumeration Name

`IviScopeTriggerCouplingEnum`

C Constant Name

`IVISCOPE_ATTR_TRIGGER_COUPLING`

Description

Specifies how the oscilloscope couples the trigger source.

Defined Values

<i>Name</i>	<i>Description</i>	
	<i>Language</i>	<i>Identifier</i>
AC	The oscilloscope AC couples the trigger signal.	
	.NET	TriggerCoupling.AC
	C	IVISCOPE_VAL_AC
	COM	IviScopeTriggerCouplingAC
DC	The oscilloscope DC couples the trigger signal.	
	.NET	TriggerCoupling.DC
	C	IVISCOPE_VAL_DC
	COM	IviScopeTriggerCouplingDC
LF Reject	The oscilloscope filters out the low frequencies from the trigger signal.	
	.NET	TriggerCoupling.LowFrequencyReject
	C	IVISCOPE_VAL_LF_REJECT
	COM	IviScopeTriggerCouplingLFReject
HF Reject	The oscilloscope filters out the high frequencies from the trigger signal.	
	.NET	TriggerCoupling.HighFrequencyReject
	C	IVISCOPE_VAL_HF_REJECT
	COM	IviScopeTriggerCouplingHFReject
Noise Reject	The oscilloscope filters out the noise from the trigger signal.	
	.NET	TriggerCoupling.NoiseReject
	C	IVISCOPE_VAL_NOISE_REJECT
	COM	IviScopeTriggerCouplingNoiseReject

.NET Exceptions

The *IVI-3.2: Inherent Capabilities Specification* defines general exceptions that may be thrown, and warning events that may be raised, by this property.

Compliance Notes

1. If an IVI-C class driver defines additional values for this attribute, the actual values shall be greater than or equal to `IVISCOPE_VAL_TRIGGER_COUPLING_CLASS_EXT_BASE` and less than `IVISCOPE_VAL_TRIGGER_COUPLING_SPECIFIC_EXT_BASE`.
2. If an IVI-C specific driver defines additional values for this attribute, the actual values shall be greater than or equal to `IVISCOPE_VAL_TRIGGER_COUPLING_SPECIFIC_EXT_BASE`.
3. If an IVI-COM specific driver implements this attribute with additional elements in its instrument specific interfaces, the actual values of the additional elements shall be greater than or equal to Trigger Coupling Specific Ext Base.

See Section 20, *IviScope Attribute Value Definitions*, for the definitions of Trigger Coupling Specific Ext Base, `IVISCOPE_VAL_TRIGGER_COUPLING_SPECIFIC_EXT_BASE` and `IVISCOPE_VAL_TRIGGER_COUPLING_CLASS_EXT_BASE`.

4.2.18. Trigger Holdoff

Data Type	Access	Applies to	Coercion	High Level Functions
ViReal64 (C/COM)	R/W	N/A	Note ¹	Configure Trigger
Ivi.Driver.PrecisionTimeSpan (.NET)	R/W	N/A	Note ¹	Configure Trigger

.NET Property Name

`Trigger.Holdoff`

COM Property Name

`Trigger.Holdoff`

C Constant Name

`IVISCOPE_ATTR_TRIGGER_HOLDOFF`

Description

Specifies the length of time the oscilloscope waits after it detects a trigger until the oscilloscope enables the trigger subsystem to detect another trigger. For C and COM, the units are seconds. For IVI.NET, the units are implicit in the definition of PrecisionTimeSpan. The Trigger Holdoff attribute affects instrument operation only when the oscilloscope requires multiple acquisitions to build a complete waveform. The oscilloscope requires multiple waveform acquisitions when it uses equivalent-time sampling or when the Acquisition Type attribute is set to Envelope or Average.

Note: Many scopes have a small, non-zero value as the minimum value for this attribute. To configure the instrument to use the shortest trigger hold-off, the user can specify a value of zero for this attribute. Therefore, the IVI Class-Compliant specific driver shall coerce any value between zero and the minimum value to the minimum value. No other coercion is allowed on this attribute.

.NET Exceptions

The *IVI-3.2: Inherent Capabilities Specification* defines general exceptions that may be thrown, and warning events that may be raised, by this property.

4.2.19. Trigger Level

Data Type	Access	Applies to	Coercion	High Level Functions
ViReal64	R/W	N/A	None	Configure Edge Trigger Source Configure Glitch Trigger Source Configure Width Trigger Source

.NET Property Name

`Trigger.Level`

COM Property Name

`Trigger.Level`

C Constant Name

`IVISCOPE_ATTR_TRIGGER_LEVEL`

Description

Specifies the voltage threshold for the trigger sub-system. The units are volts. This attribute affects instrument behavior only when the Trigger Type is set to one of the following values: Edge Trigger, Glitch Trigger, or Width Trigger.

This attribute, along with the Trigger Slope, Trigger Source, and Trigger Coupling attributes, defines the trigger event when the Trigger Type is set to Edge Trigger.

.NET Exceptions

The *IVI-3.2: Inherent Capabilities Specification* defines general exceptions that may be thrown, and warning events that may be raised, by this property.

4.2.20. Trigger Slope

Data Type	Access	Applies to	Coercion	High Level Functions
ViInt32	R/W	N/A	None	Configure Edge Trigger Source

.NET Property Name

`Trigger.Edge.Slope`

.NET Enumeration Name

`Slope`

COM Property Name

`Trigger.Edge.Slope`

COM Enumeration Name

`IviScopeTriggerSlopeEnum`

C Constant Name

`IVISCOPE_ATTR_TRIGGER_SLOPE`

Description

Specifies whether a rising or a falling edge triggers the oscilloscope.

This attribute affects instrument operation only when the Trigger Type attribute is set to Edge Trigger.

Defined Values

<i>Name</i>	<i>Description</i>	
	<i>Language</i>	<i>Identifier</i>
Positive	A positive (rising) edge passing through the trigger level triggers the oscilloscope.	
	.NET	<code>Slope.Positive</code>
	C	<code>IVISCOPE_VAL_POSITIVE</code>
COM	<code>IviScopeTriggerSlopePositive</code>	
Negative	A negative (falling) edge passing through the trigger level triggers the oscilloscope.	
	.NET	<code>Slope.Negative</code>
	C	<code>IVISCOPE_VAL_NEGATIVE</code>
COM	<code>IviScopeTriggerSlopeNegative</code>	

.NET Exceptions

The *IVI-3.2: Inherent Capabilities Specification* defines general exceptions that may be thrown, and warning events that may be raised, by this property.

4.2.21. Trigger Source

Data Type	Access	Applies to	Coercion	High Level Functions
ViString	R/W	N/A	None	Configure Edge Trigger Source Configure TV Trigger Source Configure Runt Trigger Source Configure Glitch Trigger Source Configure Width Trigger Source

.NET Property Name

`Trigger.Source`

COM Property Name

`Trigger.Source`

C Constant Name

`IVISCOPE_ATTR_TRIGGER_SOURCE`

Description

Specifies the source the oscilloscope monitors for the trigger event. The value can be a channel name alias, a driver-specific channel string, or one of the values below.

This attribute affects the instrument operation only when the Trigger Type is set to one of the following values: Edge Trigger, TV Trigger, Runt Trigger, Glitch Trigger, or Width Trigger .

Defined Values:

Trigger Source is a string. If an IVI.NET driver supports a Trigger Source and the Trigger Source is listed in IVI-3.3 *Cross Class Capabilities Specification*, Section 3 then the driver shall accept the standard string for that Trigger Source. This attribute is case insensitive, but case preserving. That is the setting is case insensitive but when reading it back the programmed case is returned. IVI.NET specific drivers may define new Trigger Source strings for Trigger Source that are not defined by IVI-3.3 *Cross Class Capabilities Specification* if needed

Name	Description	
	Language	Identifier
External	The oscilloscope waits for a trigger on the external trigger input.	
	C	IVISCOPE_VAL_EXTERNAL
	COM	"VAL_EXTERNAL"
TTL0	The oscilloscope waits until it receives a trigger on the TTL0 line.	
	C	IVISCOPE_VAL_TTL0
	COM	"VAL_TTL0"
TTL1	The oscilloscope waits until it receives a trigger on the TTL1 line.	
	C	IVISCOPE_VAL_TTL1
	COM	"VAL_TTL1"
TTL2	The oscilloscope waits until it receives a trigger on the TTL2 line.	
	C	IVISCOPE_VAL_TTL2
	COM	"VAL_TTL2"
TTL3	The oscilloscope waits until it receives a trigger on the TTL3 line.	
	C	IVISCOPE_VAL_TTL3
	COM	"VAL_TTL3"
TTL4	The oscilloscope waits until it receives a trigger on the TTL4 line.	
	C	IVISCOPE_VAL_TTL4
	COM	"VAL_TTL4"
TTL5	The oscilloscope waits until it receives a trigger on the TTL5 line.	
	C	IVISCOPE_VAL_TTL5
	COM	"VAL_TTL5"
TTL6	The oscilloscope waits until it receives a trigger on the TTL6 line.	
	C	IVISCOPE_VAL_TTL6
	COM	"VAL_TTL6"
TTL7	The oscilloscope waits until it receives a trigger on the TTL7 line.	

<i>Name</i>	<i>Description</i>	
	<i>Language</i>	<i>Identifier</i>
	C	IVISCOPE_VAL_TTL7
	COM	"VAL_TTL7"
ECL0	The oscilloscope waits until it receives a trigger on the ECL0 line.	
	C	IVISCOPE_VAL_ECL0
	COM	"VAL_ECL0"
ECL1	The oscilloscope waits until it receives a trigger on the ECL1 line.	
	C	IVISCOPE_VAL_ECL1
	COM	"VAL_ECL1"
PXI Star	The oscilloscope waits until it receives a trigger on the PXI Star bus.	
	C	IVISCOPE_VAL_PXI_STAR
	COM	"VAL_PXI_STAR"
RTSI0	The oscilloscope waits until it receives a trigger on the RTSI0 line.	
	C	IVISCOPE_VAL_RTSI_0
	COM	"VAL_RTSI_0"
RTSI1	The oscilloscope waits until it receives a trigger on the RTSI1 line.	
	C	IVISCOPE_VAL_RTSI_1
	COM	"VAL_RTSI_1"
RTSI2	The oscilloscope waits until it receives a trigger on the RTSI2 line.	
	C	IVISCOPE_VAL_RTSI_2
	COM	"VAL_RTSI_2"
RTSI3	The oscilloscope waits until it receives a trigger on the RTSI3 line.	
	C	IVISCOPE_VAL_RTSI_3
	COM	"VAL_RTSI_3"
RTSI4	The oscilloscope waits until it receives a trigger on the RTSI4 line.	
	C	IVISCOPE_VAL_RTSI_4
	COM	"VAL_RTSI_4"
RTSI5	The oscilloscope waits until it receives a trigger on the RTSI5 line.	
	C	IVISCOPE_VAL_RTSI_5
	COM	"VAL_RTSI_5"
RTSI6	The oscilloscope waits until it receives a trigger on the RTSI6 line.	
	C	IVISCOPE_VAL_RTSI_6

<i>Name</i>	<i>Description</i>	
	<i>Language</i>	<i>Identifier</i>
	COM	"VAL_RTISI_6"

.NET Exceptions

The *IVI-3.2: Inherent Capabilities Specification* defines general exceptions that may be thrown, and warning events that may be raised, by this property.

4.2.22. Trigger Type

Data Type	Access	Applies to	Coercion	High Level Functions
ViInt32	R/W	N/A	None	Configure Trigger

.NET Property Name

`Trigger.Type`

.NET Enumeration Name

`TriggerType`

COM Property Name

`Trigger.Type`

COM Enumeration Name

`IviScopeTriggerTypeEnum`

C Constant Name

`IVISCOPE_ATTR_TRIGGER_TYPE`

Description

Specifies the event that triggers the oscilloscope.

Defined Values

<i>Name</i>	<i>Description</i>	
	<i>Language</i>	<i>Identifier</i>
Edge Trigger	Configures the oscilloscope for edge triggering. An edge trigger occurs when the trigger signal specified with the Trigger Source attribute passes the voltage threshold specified with the Trigger Level attribute and has the slope specified with the Trigger Slope attribute.	
	.NET	TriggerType.Edge
	C	IVISCOPE_VAL_EDGE_TRIGGER
	COM	IviScopeTriggerEdge
TV Trigger	Configures the oscilloscope for triggering on TV signals. Use the IviScopeTVTrigger extension attributes and functions to configure the trigger.	
	.NET	TriggerType.TV
	C	IVISCOPE_VAL_TV_TRIGGER
	COM	IviScopeTriggerTV
Runt Trigger	Configures the oscilloscope for runt triggering. Use the IviScopeRuntTrigger extension attributes and functions to configure the trigger.	
	.NET	TriggerType.Runt
	C	IVISCOPE_VAL_RUNT_TRIGGER
	COM	IviScopeTriggerRunt
Glitch Trigger	Configures the oscilloscope for glitch triggering. Use the IviScopeGlitchTrigger extension attributes and functions to configure the trigger.	
	.NET	TriggerType.Glitch
	C	IVISCOPE_VAL_GLITCH_TRIGGER
	COM	IviScopeTriggerGlitch
Width Trigger	Configures the oscilloscope for width triggering. Use the IviScopeWidthTrigger extension attributes and functions to configure the trigger.	
	.NET	TriggerType.Width
	C	IVISCOPE_VAL_WIDTH_TRIGGER
	COM	IviScopeTriggerWidth
Immediate Trigger	Configures the oscilloscope for immediate triggering. The oscilloscope does not wait for trigger of any kind upon initialization.	
	.NET	TriggerType.Immediate
	C	IVISCOPE_VAL_IMMEDIATE_TRIGGER
	COM	IviScopeTriggerImmediate
AC Line Trigger	Configures the oscilloscope for AC Line triggering. Use the IviScopeACLineTrigger extension attributes and functions to configure the trigger.	
	.NET	TriggerType.ACLine

	C	IVISCOPE_VAL_AC_LINE_TRIGGER
	COM	IviScopeTriggerACLine

.NET Exceptions

The *IVI-3.2: Inherent Capabilities Specification* defines general exceptions that may be thrown, and warning events that may be raised, by this property.

Compliance Notes

1. The IVI Class-Compliant specific driver shall implement the Edge Trigger value for this attribute.
2. If an IVI-C class driver defines additional values for this attribute, the actual values shall be greater than or equal to `IVISCOPE_VAL_TRIGGER_TYPE_CLASS_EXT_BASE` and less than `IVISCOPE_VAL_TRIGGER_TYPE_SPECIFIC_EXT_BASE`.
3. If an IVI-C specific driver defines additional values for this attribute, the actual values shall be greater than or equal to `IVISCOPE_VAL_TRIGGER_TYPE_SPECIFIC_EXT_BASE`.
4. If an IVI Class-Compliant specific driver implements any of the defined values in the following table, it shall also implement the corresponding capability group:

Value	Required Capability Group
TV Trigger	IviScopeTVTrigger
Runt Trigger	IviScopeRuntTrigger
Glitch Trigger	IviScopeGlitchTrigger
Width Trigger	IviScopeWidthTrigger
AC Line Trigger	IviScopeAcLineTrigger

5. If an IVI-COM specific driver implements this attribute with additional elements in its instrument specific interfaces, the actual values of the additional elements shall be greater than or equal to Trigger Type Specific Ext Base.

See Section 20, *IviScope Attribute Value Definitions*, for the definitions of Trigger Type Specific Ext Base, `IVISCOPE_VAL_TRIGGER_TYPE_SPECIFIC_EXT_BASE` and `IVISCOPE_VAL_TRIGGER_TYPE_CLASS_EXT_BASE`.

4.2.23. Vertical Coupling

Data Type	Access	Applies to	Coercion	High Level Functions
ViInt32	R/W	Channel	None	Configure Channel

.NET Property Name

Channels[].Coupling

.NET Enumeration Name

VerticalCoupling

COM Property Name

Channels.Item().Coupling

COM Enumeration Name

IviScopeVerticalCouplingEnum

C Constant Name

IVISCOPE_ATTR_VERTICAL_COUPLING

Description

Specifies how the oscilloscope couples the input signal for the channel.

Defined Values

Name	Description	
	Language	Identifier
AC	The oscilloscope AC couples the input signal.	
	.NET	VerticalCoupling.AC
	C	IVISCOPE_VAL_AC
	COM	IviScopeVerticalCouplingAC
DC	The oscilloscope DC couples the input signal.	
	.NET	VerticalCoupling.DC
	C	IVISCOPE_VAL_DC
	COM	IviScopeVerticalCouplingDC
Gnd	The oscilloscope couples the channel to the ground.	
	.NET	VerticalCoupling.Ground
	C	IVISCOPE_VAL_GND
	COM	IviScopeVerticalCouplingGnd

.NET Exceptions

The *IVI-3.2: Inherent Capabilities Specification* defines general exceptions that may be thrown, and warning events that may be raised, by this property.

Compliance Notes

1. If an IVI-C class driver defines additional values for this attribute, the actual values shall be greater than or equal to `IVISCOPE_VAL_VERTICAL_COUPLING_CLASS_EXT_BASE` and less than `IVISCOPE_VAL_VERTICAL_COUPLING_SPECIFIC_EXT_BASE`.
2. If an IVI-C specific driver defines additional values for this attribute, the actual values shall be greater than or equal to `IVISCOPE_VAL_VERTICAL_COUPLING_SPECIFIC_EXT_BASE`.
3. If an IVI-COM specific driver implements this attribute with additional elements in its instrument specific interfaces, the actual values of the additional elements shall be greater than or equal to Vertical Coupling Specific Ext Base.

See Section 20, *IviScope Attribute Value Definitions*, for the definitions of Vertical Coupling Specific Ext Base, `IVISCOPE_VAL_VERTICAL_COUPLING_SPECIFIC_EXT_BASE` and `IVISCOPE_VAL_VERTICAL_COUPLING_CLASS_EXT_BASE`.

4.2.24. Vertical Offset

Data Type	Access	Applies to	Coercion	High Level Functions
ViReal64	R/W	Channel	None	Configure Channel

.NET Property Name

`Channels[].Offset`

COM Property Name

`Channels.Item().Offset`

C Constant Name

`IVISCOPE_ATTR_VERTICAL_OFFSET`

Description

Specifies the location of the center of the range that the Vertical Range attribute specifies. The value is with respect to ground and is in volts.

For example, to acquire a sine wave that spans between on 0.0 and 10.0 volts, set this attribute to 5.0 volts.

.NET Exceptions

The *IVI-3.2: Inherent Capabilities Specification* defines general exceptions that may be thrown, and warning events that may be raised, by this property.

4.2.25. Vertical Range

Data Type	Access	Applies to	Coercion	High Level Functions
ViReal64	R/W	Channel	Up	Configure Channel

.NET Property Name

`Channels[] .Range`

COM Property Name

`Channels.Item() .Range`

C Constant Name

`IVISCOPE_ATTR_VERTICAL_RANGE`

Description

Specifies the absolute value of the full-scale input range for a channel. The units are volts.

For example, to acquire a sine wave that spans between -5.0 and 5.0 volts, set the Vertical Range attribute to 10.0 volts.

.NET Exceptions

The *IVI-3.2: Inherent Capabilities Specification* defines general exceptions that may be thrown, and warning events that may be raised, by this property.

4.3. IviScopeBase Functions

The IviScopeBase capability group defines the following functions:

- Abort
- Acquisition Status (IVI-C & IVI-COM Only)
- Actual Record Length (IVI-C only)
- Configure Acquisition Record
- Configure Acquisition Type (IVI-C only)
- Configure Channel
- Create Waveform (IVI.NET Only)
- Configure Channel Characteristics
- Configure Edge Trigger Source
- Configure Trigger
- Configure Trigger Coupling (IVI-C only)
- GetChannelName (IVI-C Only)
- Fetch Waveform
- Initiate Acquisition
- Is Invalid Waveform Element (IVI-C & IVI-COM Only)
- Read Waveform
- Sample Rate (IVI-C only)

This section describes the behavior and requirements of each function.

4.3.1.Abort

Description

This function aborts an acquisition and returns the oscilloscope to the Idle state. This function does not check the instrument status.

Typically, the end-user calls this function only in a sequence of calls to other low-level driver functions. The sequence performs one operation. The end-user uses the low-level functions to optimize one or more aspects of interaction with the instrument. Call the Error Query function at the conclusion of the sequence to check the instrument status.

If the instrument cannot abort an initiated acquisition, the driver shall return the Function Not Supported error.

.NET Method Prototype

```
void Measurement.Abort ();
```

COM Method Prototype

```
HRESULT Measurements.Abort ();
```

C Prototype

```
ViStatus IviScope_Abort (ViSession Vi);
```

Parameters

Inputs	Description	Base Type
Vi	Instrument handle	ViSession

Return Values (C/COM)

The *IVI-3.2: Inherent Capabilities Specification* defines general status codes that this function can return.

.NET Exceptions

The *IVI-3.2: Inherent Capabilities Specification* defines general exceptions that may be thrown, and warning events that may be raised, by this method.

4.3.2.Acquisition Status (IVI-C & IVI-COM Only)

Description

Acquisition status indicates whether an acquisition is in progress, complete, or if the status is unknown.

Acquisition status is not the same as instrument status, and does not necessarily check for instrument errors. To make sure that the instrument is checked for errors after calling the acquisition status function, call the Error Query method. (Note that the end user may want to call Error Query at the end of a sequence of other calls which include calling the acquisition status function, - it does not necessarily need to be called immediately.)

If the driver cannot determine whether the acquisition is complete or not, it returns the Acquisition Status Unknown value.

.NET Method Prototype

N/A

See the Acquisition Status property.

COM Enumeration Name

IviScopeAcquisitionStatusEnum

COM Method Prototype

```
HRESULT Measurements.Status ([out,retval] IviScopeAcquisitionStatusEnum *Status);
```

C Prototype

```
ViStatus IviScope_AcquisitionStatus (ViSession Vi,  
ViInt32 *Status);
```

Parameters

Inputs	Description	Base Type
Vi	Instrument handle	ViSession

Outputs	Description	Base Type
Status	Acquisition Status	ViInt32

Defined Values for Status Parameter

<i>Name</i>	<i>Description</i>	
	<i>Language</i>	<i>Identifier</i>
Acquisition Complete	The oscilloscope has completed the acquisition.	
	C	IVISCOPE_VAL_ACQ_COMPLETE
	COM	IviScopeAcquisitionStatusComplete
Acquisition In Progress	The oscilloscope is still acquiring data.	
	C	IVISCOPE_VAL_ACQ_IN_PROGRESS
	COM	IviScopeAcquisitionStatusInProgress
Acquisition Status Unknown	The oscilloscope cannot determine the status of the acquisition.	
	C	IVISCOPE_VAL_ACQ_STATUS_UNKNOWN
	COM	IviScopeAcquisitionStatusUnknown

Return Values (C/COM)

The *IVI-3.2: Inherent Capabilities Specification* defines general status codes that this function can return.

4.3.3. Actual Record Length (IVI-C only)

Description

This function returns the actual number of points the oscilloscope acquires per channel. After configuring the oscilloscope for an acquisition, call this function to determine the size of the waveforms that the oscilloscope acquires. The value is equal to or greater than the minimum number of points specified in the Configure Acquisition Record function.

For IVI-C drivers, allocate a `ViReal64` array of this size or greater to pass as the `WaveformArray` parameter of the `IviScope_ReadWaveform` and `IviScope_FetchWaveform` functions.

The oscilloscope may use different size records depending on the acquisition type. Specify the acquisition type with the Configure Acquisition Type function.

.NET Method Prototype

N/A
(use the `Acquisition.RecordLength` property)

COM Method Prototype

N/A
(use the `Acquisition.RecordLength` property)

C Prototype

```
ViStatus IviScope_ActualRecordLength (ViSession Vi,  
                                       ViInt32 *ActualRecordLength);
```

Parameters

Inputs	Description	Base Type
Vi	Instrument handle	ViSession

Outputs	Description	Base Type
ActualRecordLength	Returns the actual number of points the oscilloscope acquires for each channel. The driver returns the value held in the Horizontal Record Length attribute. See the Horizontal Record Length attribute for a complete description.	ViInt32

Return Values (C)

The *IVI-3.2: Inherent Capabilities Specification* defines general status codes that this function can return.

4.3.4. Configure Acquisition Record

Description

This function configures the most commonly configured attributes of the oscilloscope acquisition subsystem. These attributes are the time per record, minimum record length, and the acquisition start time.

.NET Method Prototype

```
void Acquisition.ConfigureRecord (
    Ivi.Driver.PrecisionTimeSpan timePerRecord,
    Int32 minimumNumberPoints,
    Ivi.Driver.PrecisionTimeSpan acquisitionStartTime);
```

COM Method Prototype

```
HRESULT Acquisition.ConfigureRecord ([in] DOUBLE TimePerRecord,
    [in] LONG MinNumPts,
    [in] DOUBLE AcquisitionStartTime);
```

C Prototype

```
ViStatus IviScope_ConfigureAcquisitionRecord (ViSession Vi,
    ViReal64 TimePerRecord,
    ViInt32 MinNumPts,
    ViReal64 AcquisitionStartTime);
```

Parameters

Inputs	Description	Base Type
Vi	Instrument handle	ViSession
TimePerRecord	Specifies the time per record. The driver uses this value to set the Horizontal Time Per Record attribute. See the attribute description for more information.	ViReal64 (C/COM) PrecisionTimeSpan (.NET)
MinNumPts (C/COM) minimumNumberPoints (.NET)	Specifies the minimum number of points the end-user allows in the waveform recorded. The driver uses this value to set the Horizontal Minimum Number of Points attribute. See the attribute description for more information.	ViInt32
AcquisitionStartTime	Specifies the position of the first point in the waveform record relative to the trigger event. The driver uses this value to set the Acquisition Start Time attribute. See the attribute description for more information.	ViReal64 (C/COM) PrecisionTimeSpan (.NET)

Return Values (C/COM)

The *IVI-3.2: Inherent Capabilities Specification* defines general status codes that this function can return.

.NET Exceptions

The *IVI-3.2: Inherent Capabilities Specification* defines general exceptions that may be thrown, and warning events that may be raised, by this method.

4.3.5. Configure Acquisition Type (IVI-C only)

Description

This function configures how the oscilloscope acquires data and fills the waveform record.

.NET Method Prototype

N/A
(use the `Acquisition.Type` property)

COM Method Prototype

N/A
(use the `Acquisition.Type` property)

C Prototype

```
ViStatus IviScope_ConfigureAcquisitionType (ViSession Vi,  
                                             ViInt32 AcquisitionType);
```

Parameters

Inputs	Description	Base Type
Vi	Instrument handle	ViSession
AcquisitionType	Specifies the manner in which the oscilloscope acquires data and fills the waveform record. The driver sets the Acquisition Type attribute to this value. See the attribute description for more information.	ViInt32

Return Values (C)

The *IVI-3.2: Inherent Capabilities Specification* defines general status codes that this function can return.

4.3.6. Configure Channel

Description

This function configures the most commonly configured attributes of the oscilloscope channel sub-system. These attributes are the range, offset, coupling, probe attenuation, and whether the channel is enabled.

.NET Method Prototype

```
void Channels[].Configure (Double range,  
                           Double offset,  
                           VerticalCoupling coupling,  
                           Double probeAttenuation,  
                           Boolean enabled);  
  
void Channels[].Configure (Double range,  
                           Double offset,  
                           VerticalCoupling coupling,  
                           Boolean probeAttenuationAuto,  
                           Boolean enabled);
```

COM Method Prototype

```
HRESULT Channels.Item().Configure ([in] DOUBLE Range,  
                                   [in] DOUBLE Offset,  
                                   [in] IviScopeVerticalCouplingEnum Coupling,  
                                   [in] DOUBLE ProbeAttenuation,  
                                   [in] VARIANT_BOOL Enabled);
```

C Prototype

```
ViStatus IviScope_ConfigureChannel (ViSession Vi,  
                                    ViConstString Channel,  
                                    ViReal64 Range,  
                                    ViReal64 Offset,  
                                    ViInt32 Coupling,  
                                    ViReal64 ProbeAttenuation,  
                                    ViBoolean Enabled);
```

Parameters

Inputs	Description	Data Type
Vi	Instrument handle	ViSession
Channel	The name of the oscilloscope channel to configure.	ViConstString
Range	Specifies the vertical range. The driver uses this value to set the Vertical Range attribute. See the attribute description for more information.	ViReal64
Offset	Specifies the vertical offset. The driver uses this value to set the Vertical Offset attribute. See the attribute description for more information.	ViReal64
Coupling	Specifies how to couple the input signal. The driver uses this value to set the Vertical Coupling attribute. See the attribute description for more information.	ViInt32
ProbeAttenuation	Specifies the probe attenuation. The driver uses this value to set the Probe Attenuation attribute. See the attribute description for more information. In .NET, setting this parameter implicitly sets Probe Attenuation Auto to False.	ViReal64
ProbeAttenuationAuto (.NET)	Specifies the Probe Attenuation Auto setting. If set to False the driver Probe Attenuation attribute should be set to the current value selected by the algorithm. If the overload that does not include Probe Attenuation Auto is used, Probe Attenuation Auto is set to False and the Probe Attenuation attribute is set to the specified value. This is controlled implicitly with IVI-C and IVI-COM with defined values for the Probe Attenuation parameter.	ViBoolean
Enabled	Specifies if the channel is enabled for acquisition. The driver uses this value to set the Channel Enabled attribute. See the attribute description for more information	ViBoolean

Return Values (C/COM)

The *IVI-3.2: Inherent Capabilities Specification* defines general status codes that this function can return.

.NET Exceptions

The *IVI-3.2: Inherent Capabilities Specification* defines general exceptions that may be thrown, and warning events that may be raised, by this method.

Compliance Notes

The second .NET prototype that has the probeAttenuationAuto parameter is only implemented if the driver supports the IviScopeProbeAutoSense capability group. Otherwise the method overload throws a .NET System.NotSupportedException.

4.3.7. Create Waveform (IVI.NET Only)

Description

This function creates a waveform object and shall allocate the necessary memory to transfer a waveform from the instrument to the host.

If size is zero, the driver shall allocate the waveform memory with a size based on the current driver configuration.

.NET Method Prototype

```
IWaveform<Double> Measurement.CreateWaveformDouble(Int32 numberSamples);  
IWaveform<Int32> Measurement.CreateWaveformInt32(Int32 numberSamples);  
IWaveform<Int16> Measurement.CreateWaveformInt16(Int32 numberSamples);  
IWaveform<Byte> Measurement.CreateWaveformByte(Int32 numberSamples);
```

Parameters

Inputs	Description	Data Type
numberSamples	Number of samples in a waveform	Int32

Outputs	Description	Data Type
Return value	Waveform Object representing data from the channel (In .NET, this is the return value of the method.) (The <i>IVI-3.2: Inherent Capabilities Specification</i> defines the IWaveform object.)	IWaveform<T>

Refer to Section 4, *Common Properties and Methods of Waveform and Spectrum Interfaces*, and Section 5, *IWaveform<T> Interface*, of *IVI-3.18: IVI.NET Utility Classes and Interfaces Specification*, for the definition of the IWaveform object and information regarding its use.

.NET Exceptions

The *IVI-3.2: Inherent Capabilities Specification* defines general exceptions that may be thrown, and warning events that may be raised, by this method.

4.3.8. Configure Channel Characteristics

Description

This function configures the attributes that control the electrical characteristics of the channel. These attributes are the input impedance and the maximum frequency of the input signal.

.NET Method Prototype

```
void Channels[].ConfigureCharacteristics (Double inputImpedance,  
                                         Double inputFrequencyMaximum);
```

COM Method Prototype

```
HRESULT Channels.Item().ConfigureCharacteristics ([in] DOUBLE InputImpedance,  
                                                [in] DOUBLE MaxInputFrequency);
```

C Prototype

```
ViStatus IviScope_ConfigureChanCharacteristics (ViSession Vi,  
                                                ViConstString Channel,  
                                                ViReal64 InputImpedance,  
                                                ViReal64 MaxInputFrequency);
```

Parameters

Inputs	Description	Base Type
Vi	Instrument handle	ViSession
Channel	Name of the channel to configure.	ViConstString
InputImpedance	The input impedance for the channel. The driver sets the Input Impedance to this value. See the Input Impedance attribute for a complete description and defined values.	ViReal64
MaxInputFrequency (C/COM) maximumInputFrequency (.NET)	The maximum input frequency for the channel. The driver sets the Max Input Frequency to this value. See the attribute description for more information.	ViReal64

Return Values (C/COM)

The *IVI-3.2: Inherent Capabilities Specification* defines general status codes that this function can return.

.NET Exceptions

The *IVI-3.2: Inherent Capabilities Specification* defines general exceptions that may be thrown, and warning events that may be raised, by this method.

4.3.9. Configure Edge Trigger Source

Description

This function sets the edge triggering attributes. An edge trigger occurs when the trigger signal that the end-user specifies with the `Source` parameter passes through the voltage threshold that the end-user specifies with the `Level` parameter and has the slope that the end-user specifies with the `Slope` parameter.

This function affects instrument behavior only if the Trigger Type is Edge Trigger. Set the Trigger Type and Trigger Coupling before calling this function.

If the trigger source is one of the analog input channels, an application program should configure the vertical range, vertical offset, vertical coupling, probe attenuation, and the maximum input frequency before calling this function.

.NET Method Prototype

```
void Trigger.Edge.Configure (String source,  
                             Double level,  
                             Slope slope);
```

COM Method Prototype

```
HRESULT Trigger.Edge.Configure ([in] BSTR Source,  
                                [in] DOUBLE Level,  
                                [in] IviScopeTriggerSlopeEnum Slope);
```

C Prototype

```
ViStatus IviScope_ConfigureEdgeTriggerSource (ViSession Vi,  
                                                ViConstString Source,  
                                                ViReal64 Level,  
                                                ViInt32 Slope);
```

Parameters

Inputs	Description	Base Type
Vi	Instrument handle	ViSession
Source	Specifies the trigger source. The driver uses this value to set the Trigger Source attribute. See the attribute description for more information.	ViConstString
Level	Specifies the trigger level. The driver uses this value to set the Trigger Level attribute. See the attribute description for more information.	ViReal64
Slope	Specifies the trigger slope. The driver uses this value to set the Trigger Slope attribute. See the attribute description for more information.	ViInt32

Return Values (C/COM)

The *IVI-3.2: Inherent Capabilities Specification* defines general status codes that this function can return.

.NET Exceptions

The *IVI-3.2: Inherent Capabilities Specification* defines general exceptions that may be thrown, and warning events that may be raised, by this method.

4.3.10. ConfigureTrigger

Description

This function configures the common attributes of the trigger subsystem. These attributes are the trigger type and trigger holdoff.

When the end-user calls Read Waveform, Read Waveform Measurement, Read Min Max Waveform, or Initiate Acquisition, the oscilloscope waits for a trigger. The end-user specifies the type of trigger for which the oscilloscope waits with the `TriggerType` parameter.

If the oscilloscope requires multiple waveform acquisitions to build a complete waveform, it waits for the length of time the end-user specifies with the `Holdoff` parameter to elapse since the previous trigger. The oscilloscope then waits for the next trigger. Once the oscilloscope acquires a complete waveform, it returns to the idle state.

.NET Method Prototype

```
void Trigger.Configure (TriggerType type,  
                        Ivi.Driver.PrecisionTimeSpan holdoff);
```

COM Method Prototype

```
HRESULT Trigger.Configure ([in] IviScopeTriggerTypeEnum Type,  
                           [in] DOUBLE Holdoff);
```

C Prototype

```
ViStatus IviScope_ConfigureTrigger (ViSession Vi,  
                                     ViInt32 TriggerType,  
                                     ViReal64 Holdoff);
```

Parameters

Inputs	Description	Base Type
Vi	Instrument handle	ViSession
TriggerType	Specifies the trigger type. The driver uses this value to set the Trigger Type attribute. See the attribute description for more information.	ViInt32
Holdoff	Specifies the trigger hold-off. The driver uses this value to set the Trigger Holdoff attribute. See the attribute description for more information.	ViReal64 (C/ COM) PrecisionTimeSpan (.NET)

Return Values (C/COM)

The *IVI-3.2: Inherent Capabilities Specification* defines general status codes that this function can return.

.NET Exceptions

The *IVI-3.2: Inherent Capabilities Specification* defines general exceptions that may be thrown, and warning events that may be raised, by this method.

4.3.11. Configure Trigger Coupling (IVI-C only)

Description

This function sets the trigger coupling attribute.

.NET Method Prototype

N/A
(use the `Trigger.Coupling` property)

COM Method Prototype

N/A
(use the `Trigger.Coupling` property)

C Prototype

```
ViStatus IviScope_ConfigureTriggerCoupling (ViSession Vi,  
                                             ViInt32 Coupling);
```

Parameters

Inputs	Description	Base Type
Vi	Instrument handle	ViSession
Coupling	Specifies the trigger coupling. The driver uses this value to set the Trigger Coupling attribute. See the attribute description for more information.	ViInt32

Return Values (C)

The *IVI-3.2: Inherent Capabilities Specification* defines general status codes that this function can return.

4.3.12. Get Channel Name (IVI-C Only)

Description

This function returns the physical channel identifier that corresponds to the one-based index that the user specifies. If the driver defines a qualified channel name, this property returns the qualified name. If the value that the user passes for the `ChannelIndex` parameter is less than one or greater than the value of the `Channel Count`, the function returns an empty string in the `ChannelName` parameter and returns an error.

.NET Method Prototype

N/A

(Use the `Channels.Name` property)

COM Method Prototype

N/A

(Use the `Channels.Name` and `Measurements.Name` properties)

C Prototype

```
ViStatus IviScope_GetChannelName (ViSession Vi,  
                                  ViInt32 Index,  
                                  ViInt32 NameBufferSize,  
                                  ViChar Name[]);
```

Parameters

Inputs	Description	Base Type
Vi	Instrument handle	ViSession
Index	A one-based index that defines which name to return.	ViInt32
NameBufferSize	The number of bytes in the ViChar array that the user specifies for the Name parameter.	ViInt32

Outputs	Description	Base Type
Name	A user-allocated (for IVI-C) or driver-allocated (for IVI-COM) buffer into which the driver stores the channel name. The caller may pass <code>VI_NULL</code> for this parameter if the <code>NameBufferSize</code> parameter is 0.	ViChar[]

Return Values (C)

The *IVI-3.2: Inherent Capabilities Specification* defines general status codes that this function can return.

4.3.13. Fetch Waveform

Description

This function returns the waveform the oscilloscope acquires for the specified channel. The waveform is from a previously initiated acquisition.

You use the Initiate Acquisition function to start an acquisition on the channels that the end-user configures with the Configure Channel function. The oscilloscope acquires waveforms on the concurrently enabled channels. If the channel is not enabled for the acquisition, this function returns the Channel Not Enabled error.

Use this function only when the acquisition mode is Normal, Hi Res, or Average. If the acquisition type is not one of the listed types, the function returns the Invalid Acquisition Type error.

You use the Acquisition Status function to determine when the acquisition is complete. You must call this function separately for each enabled channel to obtain the waveforms.

You can call the Read Waveform function instead of the Initiate Acquisition function. The Read Waveform function starts an acquisition on all enabled channels, waits for the acquisition to complete, and returns the waveform for the specified channel. You call this function to obtain the waveforms for each of the remaining channels.

The behavior is different for IVI-C/IVI-COM and IVI.NET as follows:

IVI-C/IVI-COM: After this function executes, each element in the `waveformArray` parameter is either a voltage or a value indicating that the oscilloscope could not sample a voltage.

IVI.NET: For .NET the return value of `IWaveform<T>` is a waveform object. Refer to Section 4, *Common Properties and Methods of Waveform and Spectrum Interfaces*, and Section 5, *IWaveform<T> Interface*, of *IVI-3.18: IVI.NET Utility Classes and Interfaces Specification*, for the definition of the `IWaveform` object and information regarding its use. In particular, refer to Section 4.2, *How to use Waveform and Spectrum Types*, in *IVI-3.18: IVI.NET Utility Classes and Interfaces Specification*, for more information about how to implement these methods.

The C end-user configures the interpolation method the oscilloscope uses with the `IviScope_ConfigureInterpolation` function. The COM or .NET end-user uses the `Acquisition.Interpolation` property. If interpolation is disabled, the oscilloscope does not interpolate points in the waveform. If the oscilloscope cannot sample a value for a point in the waveform, the driver sets the corresponding element in the `waveformArray` to an IEEE-defined NaN (Not a Number) value. For C and COM, the function returns the Invalid Waveform Element warning. For .NET, the `IWaveform` return value includes a property that indicates if there is an invalid waveform element.

For C and COM, use the `Is Waveform Element Invalid` function to test each element in the `waveformArray` parameter for an invalid waveform element. For .NET, check for `Double.IsNaN` if the waveform is of type `Double`.

This function does not check the instrument status. Typically, the end-user calls this function only in a sequence of calls to other low-level driver functions. The sequence performs one operation. The end-user uses the low-level functions to optimize one or more aspects of interaction with the instrument. Call the `Error Query` function at the conclusion of the sequence to check the instrument status.

.NET Method Prototype

```

IWaveform<Double> Channels[].Measurement.FetchWaveform(
    IWaveform<Double> waveform);
IWaveform<Int32> Channels[].Measurement.FetchWaveform(
    IWaveform<Int32> waveform);
IWaveform<Int16> Channels[].Measurement.FetchWaveform(
    IWaveform<Int16> waveform);
IWaveform<Byte> Channels[].Measurement.FetchWaveform(
    IWaveform<Byte> waveform);

```

COM Method Prototype

```

HRESULT Measurements.Item().FetchWaveform (
    [in,out] SAFEARRAY(DOUBLE) *WaveformArray,
    [in,out] DOUBLE *InitialX,
    [in,out] DOUBLE *XIncrement);

```

C Prototype

```

ViStatus IviScope_FetchWaveform (ViSession Vi,
    ViConstString Channel,
    ViInt32 WaveformSize,
    ViReal64 WaveformArray[],
    ViInt32 *ActualPoints,
    ViReal64 *InitialX,
    ViReal64 *XIncrement);

```

Parameters

Inputs	Description	Base Type
Vi (C)	Instrument handle	ViSession
Channel (C)	Name of the channel from which to fetch a waveform.	ViConstString
WaveformSize (C)	Specifies the number of elements in the waveform array.	ViInt32
Waveform (.NET)	Waveform object with data of a particular size needed only for reusing waveform object across reads.	Waveform<T>

Outputs	Description	Base Type
WaveformArray (C/COM)	A user-allocated (for IVI-C) or driver-allocated (for IVI-COM) buffer into which the acquired waveform is stored. Units for the individual array elements are in volts.	ViReal64[]
ActualPoints (C)	Number of points actually placed in the waveform array.	ViInt32
InitialX(C/COM)	The time in relation to the Trigger Event of the first point in the waveform in seconds. Negative values mean that the first point in the waveform array was acquired before the trigger event.	ViReal64

XIncrement (C/COM)	The effective time between points in the acquired waveform in seconds.	ViReal64
Return Value (.NET)	Waveform object with data from the channel. (In .NET, this is the return value of the method.) (The <i>IVI-3.2: Inherent Capabilities Specification</i> defines the IWaveform object.)	IWaveform<T>

Return Values (C/COM)

The *IVI-3.2: Inherent Capabilities Specification* defines general status codes that this function can return. The table below specifies additional class-defined status codes for this function.

Completion Codes	Description
Invalid Waveform Element	Warning: One Of The Elements In The Waveform Array Is Invalid.
Invalid Acquisition Type	Error: Invalid Acquisition Type
Channel Not Enabled	Error: Specified Channel Is Not Enabled For Acquisition.

.NET Exceptions

The *IVI-3.2: Inherent Capabilities Specification* defines general exceptions that may be thrown, and warning events that may be raised, by this method. The *IVI-3-18: IVI.NET Utility Classes and Interfaces Specification* defines additional waveform-related exceptions that may be thrown by this method.

The table below specifies additional class-defined exceptions for this method.

Exception Class	Description
InvalidAquisitionTypeException	Invalid acquisition type
ChannelNotEnabledException	Specified channel is not enabled for acquisition.

4.3.14. Initiate Acquisition

Description

This function initiates a waveform acquisition. After calling this function, the oscilloscope leaves the idle state and waits for a trigger. The oscilloscope acquires a waveform for each channel the end-user has enabled with the Configure Channel function.

This function does not check the instrument status. Typically, the end-user calls this function only in a sequence of calls to other low-level driver functions. The sequence performs one operation. The end-user uses the low-level functions to optimize one or more aspects of interaction with the instrument. Call the Error Query function at the conclusion of the sequence to check the instrument status.

.NET Method Prototype

```
void Measurement.Initiate();
```

COM Method Prototype

```
HRESULT Measurements.Initiate();
```

C Prototype

```
ViStatus IviScope_InitiateAcquisition (ViSession Vi);
```

Parameters

Inputs	Description	Base Type
Vi	Instrument handle	ViSession

Return Values (C/COM)

The *IVI-3.2: Inherent Capabilities Specification* defines general status codes that this function can return.

.NET Exceptions

The *IVI-3.2: Inherent Capabilities Specification* defines general exceptions that may be thrown, and warning events that may be raised, by this method.

4.3.15.Is Waveform Element Invalid (IVI-C & IVI-COM Only)

Description

This function determines whether a value you pass from the waveform array is invalid. After the read and fetch waveform functions execute, each element in the waveform array contains either a voltage or a value indicating that the oscilloscope could not sample a voltage. The driver uses an IEEE-defined NaN (Not a Number) value to mark as invalid each element in the waveform array for which the oscilloscope could not sample a voltage. This function determines whether a value you pass from the waveform array is invalid. Refer to *IVI-3.12: Floating Point Services Specification* for more information on how to return standard floating point values to user programs.

.NET Method Prototype

N/A;

Test the element for NaN.

COM Method Prototype

```
HRESULT Measurements.IsWaveformElementInvalid ([in] DOUBLE Element,
                                               [out, retval] VARIANT_BOOL *IsValid);
```

C Prototype

```
ViStatus IviScope_IsInvalidWfmElement (ViSession Vi,
                                       ViReal64 ElementValue,
                                       ViBoolean *IsValid);
```

Parameters

Inputs	Description	Base Type
Vi	Instrument handle	ViSession
ElementValue	Pass one of the values from the waveform array returned by the read and fetch waveform functions.	ViReal64

Outputs	Description	Base Type
IsValid (C/COM)	Returns whether the <code>elementValue</code> is a valid voltage or a value indicating that the oscilloscope could not sample a voltage. Valid return values: True - The <code>elementValue</code> indicates that the oscilloscope could not sample the voltage. False - The <code>elementValue</code> is a valid voltage.	ViBoolean
Return value (.NET)	Returns whether the <code>elementValue</code> is a valid voltage or a value indicating that the oscilloscope could not sample a voltage. Valid return values: True - The <code>elementValue</code> indicates that the oscilloscope could not sample the voltage. False - The <code>elementValue</code> is a valid voltage.	Boolean

Return Values (C/COM)

The *IVI-3.2: Inherent Capabilities Specification* defines general status codes that this function can return.

.NET Exceptions

The *IVI-3.2: Inherent Capabilities Specification* defines general exceptions that may be thrown, and warning events that may be raised, by this method.

4.3.16. Read Waveform

Description

This function initiates an acquisition on the channels that the end-user configures with the `Configure Channel` function. If the channel is not enabled for the acquisition, this function returns `Channel Not Enabled` error. It then waits for the acquisition to complete, and returns the waveform for the channel the end-user specifies. If the oscilloscope did not complete the acquisition within the time period the user specified with the `MaxTimeMilliseconds` parameter, the function returns the `Max Time Exceeded` error.

Use this function only when the acquisition mode is `Normal`, `Hi Res`, or `Average`. If the acquisition type is not one of the listed types, the function returns the `Invalid Acquisition Type` error.

You call the `Fetch Waveform` function to obtain the waveforms for each of the remaining enabled channels without initiating another acquisition. After this function executes, each element in the `WaveformArray` parameter is either a voltage or a value indicating that the oscilloscope could not sample a voltage.

The behavior is different for `IVI-C/IVI-COM` and `IVI.NET` as follows:

IVI-C/IVI-COM: After this function executes, each element in the `waveformArray` parameter is either a voltage or a value indicating that the oscilloscope could not sample a voltage.

IVI.NET: For `.NET` the return value of `IWaveform<T>` is a waveform object. Refer to Section 4, *Common Properties and Methods of Waveform and Spectrum Interfaces*, and Section 5, *IWaveform<T> Interface*, of *IVI-3.18: IVI.NET Utility Classes and Interfaces Specification*, for the definition of the `IWaveform` object and information regarding its use. In particular, refer to Section 4.2, *How to use Waveform and Spectrum Types*, in *IVI-3.18: IVI.NET Utility Classes and Interfaces Specification*, for more information about how to implement these methods.

The C end-user configures the interpolation method the oscilloscope uses with the `IviScope_ConfigureInterpolation` function. The COM end-user uses the `Acquisition.Interpolation` property. If interpolation is disabled, the oscilloscope does not interpolate points in the waveform. If the oscilloscope cannot sample a value for a point in the waveform, the driver sets the corresponding element in the `WaveformArray` to an IEEE-defined `NaN` (Not a Number) value and the function returns `Invalid Wfm Element`. For C and COM, the function returns the `Invalid Waveform Element` warning. For `.NET`, the `IWaveform` return value includes a property that indicates if there is an invalid waveform element.

For C and COM, use the `Is Waveform Element Invalid` function to test each element in the `waveformArray` parameter for an invalid waveform element. For `.NET`, check for `Double.IsNaN` if the waveform is of type `Double`.

.NET Method Prototype

```
IWaveform<Double> Channels[].Measurement.ReadWaveform(
    PrecisionTimeSpan maximumTime
    IWaveform<Double> waveform);
IWaveform<Int32> Channels[].Measurement.ReadWaveform(
    PrecisionTimeSpan maximumTime
    IWaveform<Int32> waveform);
IWaveform<Int16> Channels[].Measurement.ReadWaveform(
    Precision TimeSpan maximumTime
    IWaveform<Int16> waveform);
IWaveform<Byte> Channels[].Measurement.ReadWaveform(
    Precision TimeSpan maximumTime
    IWaveform<Byte> waveform);
```

COM Method Prototype

```
HRESULT Measurements.Item().ReadWaveform ([in] LONG MaxTimeMilliseconds,  
                                           [in,out] SAFEARRAY(DOUBLE) *WaveformArray,  
                                           [in,out] DOUBLE *InitialX,  
                                           [in,out] DOUBLE *XIncrement);
```

C Prototype

```
ViStatus IviScope_ReadWaveform (ViSession vi,  
                                 ViConstString Channel,  
                                 ViInt32 WaveformSize,  
                                 ViInt32 MaxTimeMilliseconds,  
                                 ViReal64 WaveformArray[],  
                                 ViInt32 *ActualPoints,  
                                 ViReal64 *InitialX,  
                                 ViReal64 *XIncrement);
```

Parameters

Inputs	Description	Base Type
Vi	Instrument handle	ViSession
Channel	Name of the channel from which to read a waveform.	ViConstString
WaveformSize	Specifies the number of elements in the waveform array.	ViInt32
MaxTime Milliseconds (C/COM)	Specifies the maximum time the end-user allows for this function to complete in milliseconds.	ViInt32
maximumTime (.NET)	Specifies the maximum time the end-user allows for this function to complete. The units are implicit in the definition of TimeSpan.	Ivi.Driver.PrecisionTimeSpan
Waveform (.NET)	Waveform object with data of a particular size needed only for reusing waveform object across reads.	Waveform<T>

Outputs	Description	Base Type
WaveformArray (C/COM)	A user-allocated (for IVI-C) or driver-allocated (for IVI-COM) buffer into which the driver stores the waveform it reads. The units for the individual array elements are volts.	ViReal64[]
ActualPoints	Contains the number of points the driver actually places in the waveform array.	ViInt32
InitialX	Contains the time of the first point in the waveform. The value is with respect to the trigger and is in seconds. Negative values mean that the first point in the waveform array was acquired before the trigger.	ViReal64
XIncrement	Contains the effective time between points in the waveform. The units are seconds.	ViReal64
Return Value (.NET)	Waveform object with data from the channel. (In .NET, this is the return value of the method.) (The <i>IVI-3.2: Inherent Capabilities Specification</i> defines the IWaveform object.)	IWaveform<T>

Defined Values for the MaxTimeMilliseconds Parameter

<i>Name</i>	<i>Description</i>	
	<i>Language</i>	<i>Identifier</i>
Max Time Immediate	The function returns immediately. If no valid measurement value exists, the function returns an error.	
	C	IVISCOPE_VAL_MAX_TIME_IMMEDIATE
	COM	IviScopeTimeOutImmediate
Max Time Infinite	The function waits indefinitely for the measurement to complete.	
	C	IVISCOPE_VAL_MAX_TIME_INFINITE
	COM	IviScopeTimeOutInfinite

Defined Values for the maximumTime Parameter

<i>Name</i>	<i>Description</i>	
	<i>Language</i>	<i>Identifier</i>
Immediate	The function returns immediately. If no valid measurement value exists, the function returns an error.	
	.NET	PrecisionTimeSpan.Zero
Infinite	The function waits indefinitely for the measurement to complete.	
	.NET	PrecisionTimeSpan.MaxValue

Return Values (C/COM)

The *IVI-3.2: Inherent Capabilities Specification* defines general status codes that this function can return. The table below specifies additional class-defined status codes for this function.

Completion Codes	Description
Invalid Waveform Element	Warning: One of the elements in the waveform array is invalid.
Invalid Acquisition Type	Error: Invalid acquisition type
Channel Not Enabled	Error: Specified channel is not enabled for acquisition.
Max Time Exceeded	Error: Maximum time exceeded before the operation completed.

.NET Exceptions

The *IVI-3.2: Inherent Capabilities Specification* defines general exceptions that may be thrown, and warning events that may be raised, by this method. The *IVI-3-18: IVI.NET Utility Classes and Interfaces Specification* defines additional waveform-related exceptions that may be thrown by this method.

The table below specifies additional class-defined exceptions for this method.

Exception Class	Description
InvalidAquisitionTypeException	Invalid acquisition type
ChannelNotEnabledException	Specified channel is not enabled for acquisition.

Note that the .NET MaxTimeExceededException is defined in *IVI-3.2: Inherent Capabilities Specification*.

Compliance Notes

The specific instrument driver is not required to support any of the defined values for the MaxTimeMilliseconds parameter.

4.3.17. Sample Rate (IVI-C only)

Description

This function returns the effective sample rate of the acquired waveform using the current configuration in samples per second.

.NET Method Prototype

N/A
(use the `Acquisition.SampleRate` property)

COM Method Prototype

N/A
(use the `Acquisition.SampleRate` property)

C Prototype

```
ViStatus IviScope_SampleRate (ViSession Vi,  
                             ViReal64 *SampleRate);
```

Parameters

Inputs	Description	Base Type
Vi	Instrument handle	ViSession

Outputs	Description	Base Type
SampleRate	Returns the effective sample rate of the acquired waveform the oscilloscope acquires for each channel. The driver returns the value held in the Horizontal Sample Rate attribute. See the Horizontal Sample Rate attribute for a complete description.	ViReal64

Return Values (C)

The *IVI-3.2: Inherent Capabilities Specification* defines general status codes that this function can return.

4.4. IviScope Behavior Model

The following behavior diagram shows relationships between IviScopeBase capabilities and oscilloscope behavior.

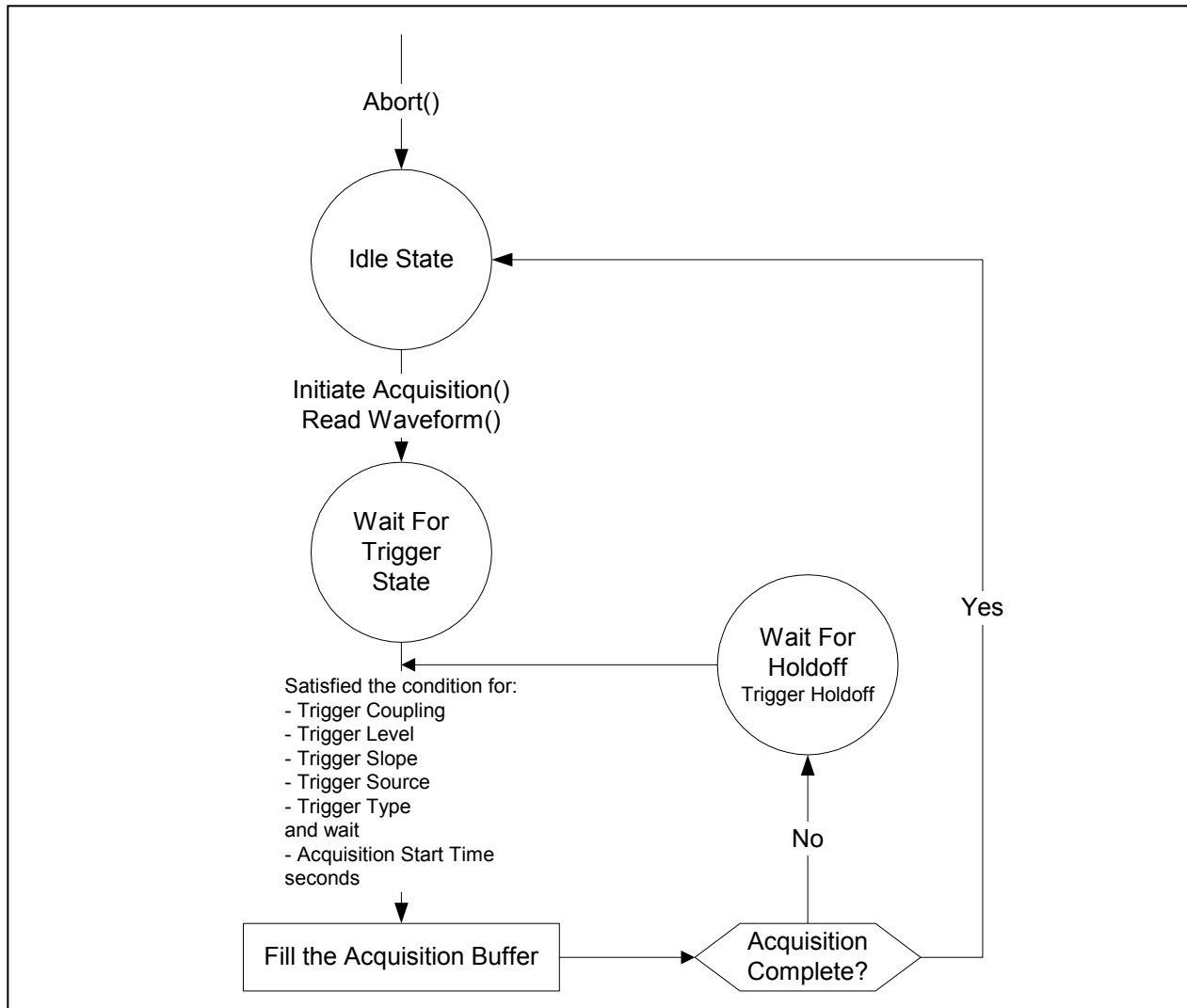

Figure 4-5. IviScope Behavior Model

Typically the user configures the oscilloscope while it is in the *Idle* state. You can configure the oscilloscope by calling the high-level configure channel, configure acquisition type, configure acquisition record, configure trigger, configure trigger coupling, and configure edge trigger source functions.

To acquire waveforms, the IviScope class presents the high-level read waveform function, as well as the low-level functions initiate acquisition, acquisition status, fetch waveform, and abort.

The Read Waveform function initiates a waveform acquisition and returns the acquired waveform after the oscilloscope has returned to the *Idle* state.

The Initiate Acquisition, Fetch Waveform, and Abort functions give the user lower-level control over the measurement process. Initiate Acquisition initiates a waveform acquisition and moves the instrument into the *Wait-For-Trigger* state. The type of trigger is configured with the Trigger sub-system attributes or with the configure edge trigger source function.

If the acquisition start time is negative, the first point in the waveform record occurs prior to the trigger event. When the trigger event occurs, the waveform record contains the amount of pre-trigger data that corresponds to the acquisition start time. The scope leaves the *Wait-for-Trigger* state and acquires the remaining points in the waveform record.

If the acquisition start time equals zero, the first point in the waveform record occurs at the time of the trigger event. When the trigger event occurs, the scope leaves the *Wait-for-Trigger* state and acquires all the points in the waveform record.

If the acquisition start time is greater than zero, the first point in the waveform record occurs after the trigger event. When the trigger event occurs, the scope leaves the wait-for-trigger state, waits a length of time that is equal to the acquisition start time, and acquires all the points in the waveform record.

If the oscilloscope was able to fill all of the points in the waveform in real-time it then returns to the *Idle* state. However, if the oscilloscope must acquire multiple waveforms in equivalent-time sampling to build up the waveform record, it then moves to the *Wait-For-Holdoff* state. The oscilloscope then waits until the hold-off time expires before moving to the *Wait-For-Trigger*.

Note that the hold-off time is measured from the moment the oscilloscope exits the *Wait-for-Trigger* state, not from the moment when the oscilloscope enters the *Wait-for-Holdoff* state.

After the instrument meets its acquisition complete criterion, the oscilloscope returns to the *Idle* state. (This criterion is typically 95-98% of the acquisition record; there may be instrument specific attributes that allow you to configure the completion criterion.) You can use the *Acquisition Status* function to determine if the acquisition is complete or is still in progress.

The *Fetch Waveform* function is used to return a waveform from a previously initiated measurement. The *Read Waveform* and *Fetch Waveform* functions return the following parameters:

- a waveform array
- the time of the first point in the waveform array in relationship to the trigger event
- the effective time interval between points in the array.

5.IviScopeInterpolation Extension Group

5.1.IviScopeInterpolation Overview

The IviScopeInterpolation extension group defines extensions for oscilloscopes capable of interpolating values in the waveform record that the oscilloscope's acquisition sub-system was unable to digitize.

5.2.IviScopeInterpolation Attributes

The IviScopeInterpolation capability group defines the following attribute:

- Interpolation

This section describes the behavior and requirements of this attribute. The actual value for this attribute ID is defined in Section 19, *IviScope Attribute ID Definitions*.

5.2.1. Interpolation

Data Type	Access	Applies to	Coercion	High Level Functions
ViInt32	R/W	N/A	None	Configure Interpolation (IVI-C only)

.NET Property Name

Acquisition.Interpolation

.NET Enumeration Name

Interpolation

COM Property Name

Acquisition.Interpolation

COM Enumeration Name

IviScopeInterpolationEnum

C Constant Name

IVISCOPE_ATTR_INTERPOLATION

Description

Specifies the interpolation method the oscilloscope uses when it cannot resolve a voltage for every point in the waveform record.

Defined Values

<i>Name</i>	<i>Description</i>	
	<i>Language</i>	<i>Identifier</i>
No Interpolation	The oscilloscope does not interpolate points in the waveform. Instead, the driver sets every element in the waveform record for which the oscilloscope cannot receive a value to an IEEE-defined NaN (Not-a-Number) value. Use the Is Waveform Element Invalid function to determine if the waveform record element is invalid.	
	.NET	Interpolation.None
	C	IVISCOPE_VAL_NO_INTERPOLATION
	COM	IviScopeInterpolationNone
Sine X	The oscilloscope uses a $\sin(x)/x$ calculation to interpolate a value when it cannot resolve a voltage in the waveform record.	
	.NET	Interpolation.SineXOverX
	C	IVISCOPE_VAL_SINE_X
	COM	IviScopeInterpolationSineX
Linear	The oscilloscope uses a linear approximation to interpolate a value when it cannot resolve a voltage in the waveform record.	
	.NET	Interpolation.Linear
	C	IVISCOPE_VAL_LINEAR
	COM	IviScopeInterpolationLinear

.NET Exceptions

The *IVI-3.2: Inherent Capabilities Specification* defines general exceptions that may be thrown, and warning events that may be raised, by this method.

Compliance Notes

1. If an IVI-C class driver defines additional values for this attribute, the actual values shall be greater than or equal to `IVISCOPE_VAL_INTERPOLATION_CLASS_EXT_BASE` and less than `IVISCOPE_VAL_INTERPOLATION_SPECIFIC_EXT_BASE`.
2. If an IVI-C specific driver defines additional values for this attribute, the actual values shall be greater than or equal to `IVISCOPE_VAL_INTERPOLATION_SPECIFIC_EXT_BASE`.
3. If an IVI-COM specific driver implements this attribute with additional elements in its instrument specific interfaces, the actual values of the additional elements shall be greater than or equal to `Interpolation Specific Ext Base`.

See Section 20, *IviScope Attribute Value Definitions*, for the definitions of `Interpolation Specific Ext Base`, `IVISCOPE_VAL_INTERPOLATION_SPECIFIC_EXT_BASE` and `IVISCOPE_VAL_INTERPOLATION_CLASS_EXT_BASE`.

5.3. IviScopeInterpolation Functions

The IviScopeInterpolation capability group defines the following function for IVI-C driver only:

- Configure Interpolation (IVI-C only)

This section describes the behavior and requirements of this function.

5.3.1. Configure Interpolation (IVI-C only)

Description

This function configures the interpolation method the oscilloscope uses when it cannot sample a voltage for a point in the waveform record.

.NET Method Prototype

N/A
(use the `Acquisition.Interpolation` property)

COM Method Prototype

N/A
(use the `Acquisition.Interpolation` property)

C Prototype

```
ViStatus IviScope_ConfigureInterpolation (ViSession Vi,  
                                           ViInt32 Interpolation);
```

Parameters

Inputs	Description	Base Type
Vi	Instrument handle	ViSession
Interpolation	Specifies interpolation method the oscilloscope uses when it cannot sample a voltage for a point in the waveform record. The driver sets the Interpolation attribute to this value. See the Interpolation attribute for a complete description and defined values.	ViInt32

Return Values (C)

The *IVI-3.2: Inherent Capabilities Specification* defines general status codes that this function can return.

5.4. IviScopeInterpolation Behavior Model

The IviScopeInterpolation group uses the behavior model defined by the IviScopeBase Capabilities.

6. IviScopeTVTrigger Extension Group

6.1. IviScopeTVTrigger Overview

The IviScopeTVTrigger extension group defines extensions for oscilloscopes capable of triggering on TV signals.

6.2. IviScopeTVTrigger Attributes

The IviScopeInterpolation capability group defines the following attributes:

- TV Trigger Event
- TV Trigger Line Number
- TV Trigger Polarity
- TV Trigger Signal Format

This section describes the behavior and requirements of each attribute. The actual value for each attribute ID is defined in Section 19, *IviScope Attribute ID Definitions*.

6.2.1.TV Trigger Event

Data Type	Access	Applies to	Coercion	High Level Functions
ViInt32	R/W	N/A	None	Configure TV Trigger Source

.NET Property Name

`Trigger.TV.TriggerEvent`

.NET Enumeration Name

`TVTriggerEvent`

COM Property Name

`Trigger.TV.Event`

COM Enumeration Name

`IviScopeTVTriggerEventEnum`

C Constant Name

`IVISCOPE_ATTR_TV_TRIGGER_EVENT`

Description

Specifies the event on which the oscilloscope triggers.

Defined Values

<i>Name</i>	<i>Description</i>	
	<i>Language</i>	<i>Identifier</i>
TV Event Field 1	Sets the oscilloscope to trigger on field 1 of the video signal.	
	.NET	TVTriggerEvent.Field1
	C	IVISCOPE_VAL_TV_EVENT_FIELD1
	COM	IviScopeTVTriggerEventField1
TV Event Field 2	Sets the oscilloscope to trigger on field 2 of the video signal.	
	.NET	TVTriggerEvent.Field2
	C	IVISCOPE_VAL_TV_EVENT_FIELD2
	COM	IviScopeTVTriggerEventField2
TV Event Any Field	Sets the oscilloscope to trigger on any field.	
	.NET	TVTriggerEvent.AnyField
	C	IVISCOPE_VAL_TV_EVENT_ANY_FIELD
	COM	IviScopeTVTriggerEventAnyField
TV Event Any Line	Sets the oscilloscope to trigger on any line.	
	.NET	TVTriggerEvent.AnyLine
	C	IVISCOPE_VAL_TV_EVENT_ANY_LINE
	COM	IviScopeTVTriggerEventAnyLine
TV Event Line Number	Sets the oscilloscope to trigger on a specific line number you specify with the TV Trigger Line Number attribute.	
	.NET	TVTriggerEvent.LineNumber
	C	IVISCOPE_VAL_TV_EVENT_LINE_NUMBER
	COM	IviScopeTVTriggerEventLineNumber

.NET Exceptions

The *IVI-3.2: Inherent Capabilities Specification* defines general exceptions that may be thrown, and warning events that may be raised, by this method.

Compliance Notes

1. If an IVI-C class driver defines additional values for this attribute, the actual values shall be greater than or equal to `IVISCOPE_VAL_TV_TRIGGER_EVENT_CLASS_EXT_BASE` and less than `IVISCOPE_VAL_TV_TRIGGER_EVENT_SPECIFIC_EXT_BASE`.
2. If an IVI-C specific driver defines additional values for this attribute, the actual values shall be greater than or equal to `IVISCOPE_VAL_TV_TRIGGER_EVENT_SPECIFIC_EXT_BASE`.
3. If an IVI Class-Compliant specific driver implements the TV Event Line Number value, it shall also implement the TV Trigger Line Number attribute. An IVI-C specific driver shall also implement the `IviScope_ConfigureTVTriggerLineNumber` function.

4. If an IVI-COM specific driver implements this attribute with additional elements in its instrument specific interfaces, the actual values of the additional elements shall be greater than or equal to TV Trigger Event Specific Ext Base.

See Section 20, *IviScope Attribute Value Definitions*, for the definitions of TV Trigger Event Specific Ext Base, `IVISCOPE_VAL_TV_TRIGGER_EVENT_SPECIFIC_EXT_BASE` and `IVISCOPE_VAL_TV_TRIGGER_EVENT_CLASS_EXT_BASE`.

6.2.2.TV Trigger Line Number

Data Type	Access	Applies to	Coercion	High Level Functions
ViInt32	R/W	N/A	None	Configure TV Trigger Line Number

.NET Property Name

`Trigger.TV.LineNumber`

COM Property Name

`Trigger.TV.LineNumber`

C Constant Name

`IVISCOPE_ATTR_TV_TRIGGER_LINE_NUMBER`

Description

Specifies the line on which the oscilloscope triggers. The driver uses this attribute when the TV Trigger Event is set to TV Event Line Number. The line number setting is independent of the field. This means that to trigger on the first line of the second field, the user must configure the line number to the value of 263 (if we presume that field one had 262 lines).

.NET Exceptions

The *IVI-3.2: Inherent Capabilities Specification* defines general exceptions that may be thrown, and warning events that may be raised, by this method.

Compliance Notes

1. An IVI Class-Compliant specific driver shall implement this attribute only if it implements the TV Event Line Number value for the TV Trigger Event attribute.
2. If an IVI-C specific driver implements this attribute, then it shall also implement the `IviScope_ConfigureTVTriggerLineNumber` function.

6.2.3.TV Trigger Polarity

Data Type	Access	Applies to	Coercion	High Level Functions
ViInt32	R/W	N/A	None	Configure TV Trigger Source

.NET Property Name

`Trigger.TV.Polarity`

.NET Enumeration Name

`TVTriggerPolarity`

COM Property Name

`Trigger.TV.Polarity`

COM Enumeration Name

`IviScopeTVTriggerPolarityEnum`

C Constant Name

`IVISCOPE_ATTR_TV_TRIGGER_POLARITY`

Description

Specifies the polarity of the TV signal.

Defined Values

Name	Description	
	Language	Identifier
TV Positive	Configures the oscilloscope to trigger on a positive video sync pulse.	
	.NET	<code>TVTriggerPolarity.Positive</code>
	C	<code>IVISCOPE_VAL_TV_POSITIVE</code>
COM	<code>IviScopeTVTriggerPolarityPositive</code>	
TV Negative	Configures the oscilloscope to trigger on a negative video sync pulse.	
	.NET	<code>TVTriggerPolarity.Negative</code>
	C	<code>IVISCOPE_VAL_TV_NEGATIVE</code>
COM	<code>IviScopeTVTriggerPolarityNegative</code>	

.NET Exceptions

The *IVI-3.2: Inherent Capabilities Specification* defines general exceptions that may be thrown, and warning events that may be raised, by this method.

6.2.4. TV Trigger Signal Format

Data Type	Access	Applies to	Coercion	High Level Functions
ViInt32	R/W	N/A	None	Configure TV Trigger Source

.NET Property Name

Trigger.TV.SignalFormat

.NET Enumeration Name

TVSignalFormat

COM Property Name

Trigger.TV.SignalFormat

COM Enumeration Name

IviScopeTVSignalFormatEnum

C Constant Name

IVISCOPE_ATTR_TV_TRIGGER_SIGNAL_FORMAT

Description

Specifies the format of TV signal on which the oscilloscope triggers

Defined Values

Name	Description	
	Language	Identifier
NTSC	Configures the oscilloscope to trigger on the NTSC signal format.	
	.NET	TVSignalFormat.Ntsc
	C	IVISCOPE_VAL_NTSC
	COM	IviScopeTVSignalFormatNTSC
PAL	Configures the oscilloscope to trigger on the PAL signal format	
	.NET	TVSignalFormat.Pal
	C	IVISCOPE_VAL_PAL
	COM	IviScopeTVSignalFormatPAL
SECAM	Configures the oscilloscope to trigger on the SECAM signal format	
	.NET	TVSignalFormat.Secam
	C	IVISCOPE_VAL_SECAM
	COM	IviScopeTVSignalFormatSECAM

.NET Exceptions

The *IVI-3.2: Inherent Capabilities Specification* defines general exceptions that may be thrown, and warning events that may be raised, by this method.

Compliance Notes

1. If an IVI-C class driver defines additional values for this attribute, the actual values shall be greater than or equal to `IVISCOPE_VAL_SIGNAL_FMT_CLASS_EXT_BASE` and less than `IVISCOPE_VAL_SIGNAL_FMT_SPECIFIC_EXT_BASE`.
2. If an IVI-C specific driver defines additional values for this attribute, the actual values shall be greater than or equal to `IVISCOPE_VAL_TV_TRIGGER_SIGNAL_FMT_SPECIFIC_EXT_BASE`.
3. If an IVI-COM specific driver implements this attribute with additional elements in its instrument specific interfaces, the actual values of the additional elements shall be greater than or equal to TV Trigger Signal Format Specific Ext Base.

See Section 20, *IviScope Attribute Value Definitions*, for the definitions of TV Trigger Signal Format Specific Ext Base, `IVISCOPE_VAL_TV_TRIGGER_SIGNAL_FMT_SPECIFIC_EXT_BASE` and `IVISCOPE_VAL_TV_TRIGGER_SIGNAL_FMT_CLASS_EXT_BASE`.

6.3. IviScopeTVTrigger Functions

The IviScopeTVTrigger capability group defines the following functions:

- Configure TV Trigger Line Number (IVI-C only)
- Configure TV Trigger Source

This section describes the behavior and requirements of each function.

6.3.1. Configure TV Trigger Line Number (IVI-C only)

Description

This function configures the TV line upon which the oscilloscope triggers. The line number is absolute and not relative to the field of the TV signal.

This function affects instrument behavior only if the trigger type is set to the TV Trigger value and the TV trigger event is set to the TV Event Line Number value. Call the Configure TV Trigger Source function to set the TV trigger event before calling this function.

.NET Method Prototype

N/A
(use the `Trigger.TV.LineNumber` property)

COM Method Prototype

N/A
(use the `Trigger.TV.LineNumber` property)

C Prototype

```
ViStatus IviScope_ConfigureTVTriggerLineNumber (ViSession Vi,  
                                               ViInt32 TVLineNumber);
```

Parameters

Inputs	Description	Base Type
Vi	Instrument handle	ViSession
TVLineNumber	Specifies the TV trigger line number. The driver sets the TV Trigger Line Number attribute to this value. See the TV Trigger Line Number attribute description for details.	ViInt32

Return Values (C)

The *IVI-3.2: Inherent Capabilities Specification* defines general status codes that this function can return.

Compliance Notes

If an IVI-C specific driver implements this function, then this driver shall implement the TV Trigger Line Number attribute and also it shall implement the TV Event Line Number value for the TV Trigger Event attribute.

6.3.2. Configure TV Trigger Source

Description

This function configures the oscilloscope for TV triggering. It configures the TV signal format, the event and the signal polarity.

This function affects instrument behavior only if the trigger type is TV Trigger. Set the Trigger Type and Trigger Coupling before calling this function.

.NET Method Prototype

```
void Trigger.TV.Configure (String source,  
                          TVSignalFormat signalFormat,  
                          TVTriggerEvent event,  
                          TVTriggerPolarity polarity);
```

COM Method Prototype

```
HRESULT Trigger.TV.Configure ([in] BSTR Source,  
                              [in] IviScopeTVSignalFormatEnum SignalFormat,  
                              [in] IviScopeTVTriggerEventEnum Event,  
                              [in] IviScopeTVTriggerPolarityEnum Polarity);
```

C Prototype

```
ViStatus IviScope_ConfigureTVTriggerSource (ViSession Vi,  
                                             ViConstString Source,  
                                             ViInt32 TVSignalFormat,  
                                             ViInt32 TVEvent,  
                                             ViInt32 TVPolarity);
```

Parameters

Inputs	Description	Base Type
Vi	Instrument handle	ViSession
Source	Specifies the trigger source. The driver uses this value to set the Trigger Source attribute. See the Trigger Source attribute description for more information.	ViConstString
TVSignalFormat	Specifies the TV trigger signal format. The driver uses this value to set the TV Trigger Signal Format attribute. See the TV Trigger Signal Format attribute description for more information.	ViInt32
TVEvent	Specifies the TV trigger event. The driver uses this value to set the TV Trigger Event attribute. See the TV Trigger Event attribute description for more information.	ViInt32
TVPolarity	Specifies the polarity of the TV trigger. The driver uses this value to set the TV Trigger Polarity attribute. See the TV Trigger Polarity attribute description for more information.	ViInt32

Return Values (C/COM)

The *IVI-3.2: Inherent Capabilities Specification* defines general status codes that this function can return.

.NET Exceptions

The *IVI-3.2: Inherent Capabilities Specification* defines general exceptions that may be thrown, and warning events that may be raised, by this method.

6.4. IviScopeTVTrigger Behavior Model

The IviScopeTVTrigger group uses the behavior model defined by the IviScopeBase Capabilities.

6.5. IviScopeTVTrigger Compliance Notes

IVI Class-Compliant specific drivers that implement this extension group shall implement the TV Trigger value for the Trigger Type attribute in the IviScopeBase capabilities group.

7.IviScopeRuntTrigger Extension Group

7.1.IviScopeRuntTrigger Overview

In addition to the fundamental capabilities, the IviScopeRuntTrigger extension group defines extensions for oscilloscopes with the capability to trigger on “runt” pulses.

A runt condition occurs when the oscilloscope detects a positive or negative going pulse that crosses one voltage threshold but fails to cross a second threshold before re-crossing the first. The figure below shows both positive and negative runt polarities.

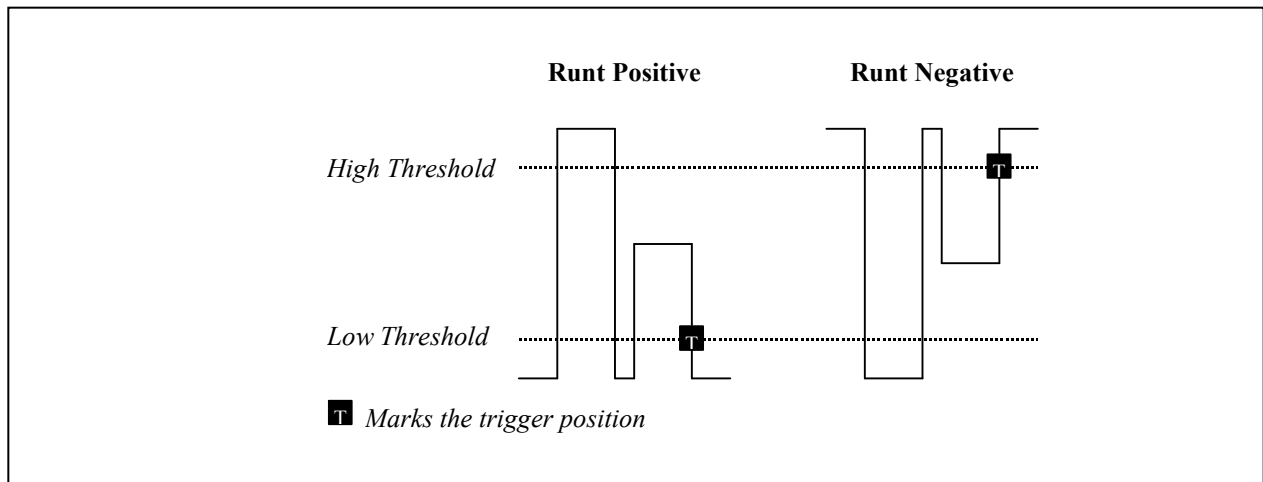

Figure 7-1. Runt Triggers

With the IviScopeRuntTrigger extension group the end-user can select whether a positive runt, negative runt, or either triggers the acquisition.

7.2.IviScopeRuntTrigger Attributes

The IviScopeRuntTrigger capability group defines the following attributes:

- Runt High Threshold
- Runt Low Threshold
- Runt Polarity

This section describes the behavior and requirements of each attribute. The actual value for each attribute ID is defined in Section 19, *IviScope Attribute ID Definitions*.

7.2.1. Runt High Threshold

Data Type	Access	Applies to	Coercion	High Level Functions
ViReal64	R/W	N/A	None	Configure Runt Trigger Source

.NET Property Name

`Trigger.Runt.ThresholdHigh`

COM Property Name

`Trigger.Runt.ThresholdHigh`

C Constant Name

`IVISCOPE_ATTR_RUNT_HIGH_THRESHOLD`

Description

Specifies the high threshold the oscilloscope uses for runt triggering. The units are volts.

.NET Exceptions

The *IVI-3.2: Inherent Capabilities Specification* defines general exceptions that may be thrown, and warning events that may be raised, by this method.

7.2.2. Runt Low Threshold

Data Type	Access	Applies to	Coercion	High Level Functions
ViReal64	R/W	N/A	None	Configure Runt Trigger Source

.NET Property Name

`Trigger.Runt.ThresholdLow`

COM Property Name

`Trigger.Runt.ThresholdLow`

C Constant Name

`IVISCOPE_ATTR_RUNT_LOW_THRESHOLD`

Description

Specifies the low threshold the oscilloscope uses for runt triggering. The units are volts.

.NET Exceptions

The *IVI-3.2: Inherent Capabilities Specification* defines general exceptions that may be thrown, and warning events that may be raised, by this method.

7.2.3.Runt Polarity

Data Type	Access	Applies to	Coercion	High Level Functions
ViInt32 (C/COM)	R/W	N/A	None	Configure Runt Trigger Source
Polarity (.NET)	R/W	N/A	None	Configure Runt Trigger Source

.NET Property Name

`Trigger.Runt.Polarity`

.NET Enumeration Name

`Polarity`

COM Property Name

`Trigger.Runt.Polarity`

COM Enumeration Name

`IviScopeRuntPolarityEnum`

C Constant Name

`IVISCOPE_ATTR_RUNT_POLARITY`

Description

Specifies the polarity of the runt that triggers the oscilloscope.

Defined Values

<i>Name</i>	<i>Description</i>	
	<i>Language</i>	<i>Identifier</i>
Runt Positive	The oscilloscope triggers on a positive runt. A positive runt occurs when a rising edge crosses the low runt threshold and does not cross the high runt threshold before re-crossing the low runt threshold.	
	.NET	Polarity.Positive
	C	IVISCOPE_VAL_RUNT_POSITIVE
	COM	IviScopeRuntPolarityPositive
Runt Negative	The oscilloscope triggers on a negative runt. A negative runt occurs when a falling edge crosses the high runt threshold and does not cross the low runt threshold before re-crossing the high runt threshold.	
	.NET	Polarity.Negative
	C	IVISCOPE_VAL_RUNT_NEGATIVE
	COM	IviScopeRuntPolarityNegative
Runt Either	The oscilloscope triggers on either a positive or negative runt.	
	.NET	Polarity.Either
	C	IVISCOPE_VAL_RUNT_EITHER
	COM	IviScopeRuntPolarityEither

.NET Exceptions

The *IVI-3.2: Inherent Capabilities Specification* defines general exceptions that may be thrown, and warning events that may be raised, by this method.

7.3. IviScopeRuntTrigger Functions

The IviScopeRuntTrigger capability group defines the following function:

- Configure Runt Trigger Source

This section describes the behavior and requirements of this function.

7.3.1.ConfigureRuntTriggerSource

Description

This function configures the runt trigger. A runt trigger occurs when the trigger signal crosses one of the runt thresholds twice without crossing the other runt threshold. The end-user specifies the runt thresholds with the `RuntLowThreshold` and `RuntHighThreshold` parameters. The end-user specifies the polarity of the runt with the `RuntPolarity` parameter.

This function affects instrument behavior only if the trigger type is Runt Trigger. Set the trigger type and trigger coupling before calling this function.

.NET Method Prototype

```
void Trigger.Runt.Configure (String source,  
                             Double thresholdLow,  
                             Double thresholdHigh,  
                             Polarity polarity);
```

COM Method Prototype

```
HRESULT Trigger.Runt.Configure ([in] BSTR Source,  
                                [in] DOUBLE ThresholdLow,  
                                [in] DOUBLE ThresholdHigh,  
                                [in] IviScopeRuntPolarityEnum Polarity);
```

C Prototype

```
ViStatus IviScope_ConfigureRuntTriggerSource (ViSession Vi,  
                                              ViConstString Source,  
                                              ViReal64 RuntLowThreshold,  
                                              ViReal64 RuntHighThreshold,  
                                              ViInt32 RuntPolarity);
```

Parameters

Inputs	Description	Base Type
Vi	Instrument handle	ViSession
Source	Specifies the trigger source. The driver uses this value to set the Trigger Source attribute. See the attribute description for more information.	ViConstString
RuntLowThreshold	Sets the runt triggering low threshold in volts. See attribute Runt Low Threshold for a complete description.	ViReal64
RuntHighThreshold	Sets the runt triggering high threshold in volts. See attribute Runt High Threshold for a complete description.	ViReal64
RuntPolarity	Sets the runt polarity. See attribute Runt Polarity for a complete description and defined values.	ViInt32

Return Values (C/COM)

The *IVI-3.2: Inherent Capabilities Specification* defines general status codes that this function can return..NET Exceptions

The *IVI-3.2: Inherent Capabilities Specification* defines general exceptions that may be thrown, and warning events that may be raised, by this method.

7.4. IviScopeRuntTrigger Behavior Model

The IviScopeRuntTrigger group uses the behavior model defined by the IviScopeBase Capabilities.

7.5. IviScopeRuntTrigger Compliance Notes

IVI Class-Compliant specific drivers that implement this extension group shall implement the Runt Trigger value for the Trigger Type attribute in the IviScopeBase capabilities group.

8.IviScopeGlitchTrigger Extension Group

8.1.IviScopeGlitchTrigger Overview

In addition to the fundamental capabilities, the IviScopeGlitchTrigger extension group defines extensions for oscilloscopes that can trigger on a “glitch” pulses.

A glitch occurs when the oscilloscope detects a pulse width that is less than or a greater than a specified glitch duration. The figure below shows both positive and negative glitches for the “less than” condition as well as the positive “greater than” glitch.

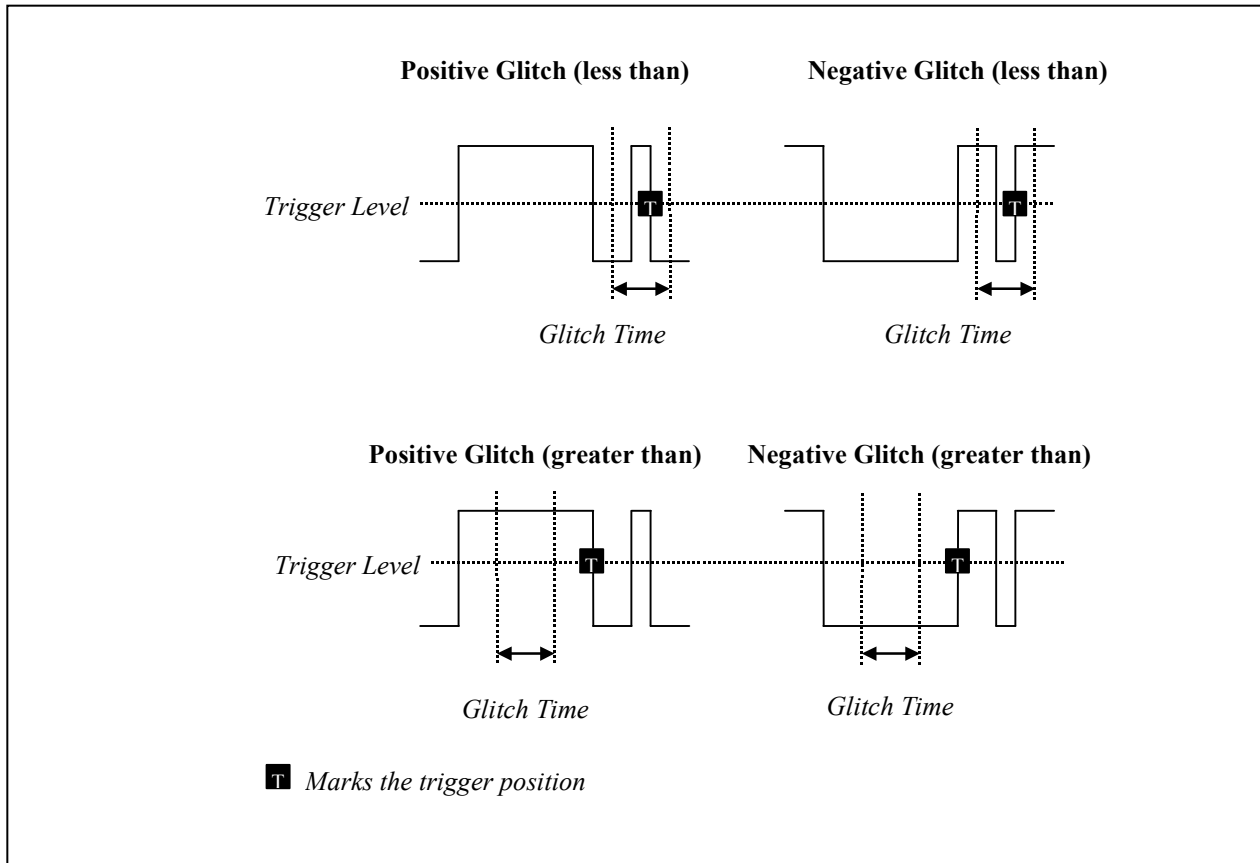

Figure 8-1. Glitch Triggers

With the IviScopeGlitchTrigger extension group the end-user can select whether a positive glitch, negative glitch, or either triggers the acquisition.

8.2. IviScopeGlitchTrigger Attributes

The IviScopeGlitchTrigger capability group defines the following attributes:

- Glitch Condition
- Glitch Polarity
- Glitch Width

This section describes the behavior and requirements of each attribute. The actual value for each attribute ID is defined in Section 19, *IviScope Attribute ID Definitions*.

8.2.1. Glitch Condition

Data Type	Access	Applies to	Coercion	High Level Functions
ViInt32	R/W	N/A	None	Configure Glitch Trigger Source

.NET Property Name

`Trigger.Glitch.Condition`

.NET Enumeration Name

`GlitchCondition`

COM Property Name

`Trigger.Glitch.Condition`

COM Enumeration Name

`IviScopeGlitchConditionEnum`

C Constant Name

`IVISCOPE_ATTR_GLITCH_CONDITION`

Description

Specifies the glitch condition. This attribute determines whether the glitch trigger happens when the oscilloscope detects a pulse with a width less than or greater than the width value

Defined Values

<i>Name</i>	<i>Description</i>	
	<i>Language</i>	<i>Identifier</i>
Glitch Greater Than	The oscilloscope triggers when the pulse width is greater than the value you specify with the Glitch Width attribute.	
	.NET	<code>GlitchCondition.GreaterThan</code>
	C	<code>IVISCOPE_VAL_GLITCH_GREATER_THAN</code>
	COM	<code>IviScopeGlitchConditionGreaterThan</code>
Glitch Less Than	The oscilloscope triggers when the pulse width is less than the value you specify with the Glitch Width attribute.	
	.NET	<code>GlitchCondition.LessThan</code>
	C	<code>IVISCOPE_VAL_GLITCH_LESS_THAN</code>
	COM	<code>IviScopeGlitchConditionLessThan</code>

.NET Exceptions

The *IVI-3.2: Inherent Capabilities Specification* defines general exceptions that may be thrown, and warning events that may be raised, by this method.

8.2.2. Glitch Polarity

Data Type	Access	Applies to	Coercion	High Level Functions
ViInt32 (C/COM)	R/W	N/A	None	Configure Glitch Trigger Source
Polarity (.NET)	R/W	N/A	None	Configure Glitch Trigger Source

.NET Property Name

`Trigger.Glitch.Polarity`

.NET Enumeration Name

`Polarity`

COM Property Name

`Trigger.Glitch.Polarity`

COM Enumeration Name

`IviScopeGlitchPolarityEnum`

C Constant Name

`IVISCOPE_ATTR_GLITCH_POLARITY`

Description

Specifies the polarity of the glitch that triggers oscilloscope.

Defined Values

<i>Name</i>	<i>Description</i>	
	<i>Language</i>	<i>Identifier</i>
Glitch Positive	The oscilloscope triggers on a positive glitch.	
	.NET	Polarity.Positive
	C	IVISCOPE_VAL_GLITCH_POSITIVE
	COM	IviScopeGlitchPolarityPositive
Glitch Negative	The oscilloscope triggers on a negative glitch.	
	.NET	Polarity.Negative
	C	IVISCOPE_VAL_GLITCH_NEGATIVE
	COM	IviScopeGlitchPolarityNegative
Glitch Either	The oscilloscope triggers on either a positive or negative glitch.	
	.NET	Polarity.Either
	C	IVISCOPE_VAL_GLITCH_EITHER
	COM	IviScopeGlitchPolarityEither

.NET Exceptions

The *IVI-3.2: Inherent Capabilities Specification* defines general exceptions that may be thrown, and warning events that may be raised, by this method.

8.2.3. Glitch Width

Data Type	Access	Applies to	Coercion	High Level Functions
ViReal64 (C/COM)	R/W	N/A	None	Configure Glitch Trigger Source
Ivi.Driver.PrecisionTimeSpan (.NET)	R/W	N/A	None	Configure Glitch Trigger Source

.NET Property Name

Trigger.Glitch.Width

COM Property Name

Trigger.Glitch.Width

C Constant Name

IVISCOPE_ATTR_GLITCH_WIDTH

Description

Specifies the glitch width. For C and COM, the units are seconds. For IVI.NET, the units are implicit in the definition of PrecisionTimeSpan. The oscilloscope triggers when it detects a pulse with a width less than or greater than this value, depending on the Glitch Condition attribute.

.NET Exceptions

The *IVI-3.2: Inherent Capabilities Specification* defines general exceptions that may be thrown, and warning events that may be raised, by this method.

8.3.IviScopeGlitchTrigger Functions

The IviScopeGlitchTrigger capability group defines the following function:

- Configure Glitch Trigger Source

This section describes the behavior and requirements of this function.

8.3.1. Configure Glitch Trigger Source

Description

This function configures the glitch trigger. A glitch trigger occurs when the trigger signal has a pulse with a width that is less than or greater than the glitch width. The end user specifies which comparison criterion to use with the `GlitchCondition` parameter. The end-user specifies the glitch width with the `GlitchWidth` parameter. The end-user specifies the polarity of the pulse with the `GlitchPolarity` parameter. The trigger does not actually occur until the edge of a pulse that corresponds to the `GlitchWidth` and `GlitchPolarity` crosses the threshold the end-user specifies in the `TriggerLevel` parameter.

This function affects instrument behavior only if the trigger type is Glitch Trigger. Set the trigger type and trigger coupling before calling this function.

.NET Method Prototype

```
void Trigger.Glitch.Configure (String source,  
                              Double level,  
                              Ivi.Driver.PrecisionTimeSpan width,  
                              Polarity polarity,  
                              GlitchCondition condition)
```

COM Method Prototype

```
HRESULT Trigger.Glitch.Configure ([in] BSTR Source,  
                                   [in] DOUBLE Level,  
                                   [in] DOUBLE Width,  
                                   [in] IviScopeGlitchPolarityEnum Polarity,  
                                   [in] IviScopeGlitchConditionEnum Condition)
```

C Prototype

```
ViStatus IviScope_ConfigureGlitchTriggerSource (ViSession Vi,  
                                                ViConstString Source,  
                                                ViReal64 Level,  
                                                ViReal64 GlitchWidth,  
                                                ViInt32 GlitchPolarity,  
                                                ViInt32 GlitchCondition);
```

Parameters

Inputs	Description	Base Type
Vi	Instrument handle	ViSession
Source	Specifies the trigger source. The driver uses this value to set the Trigger Source attribute. See the attribute description for more information.	ViConstString
Level	Specifies the trigger level. The driver uses this value to set the Trigger Level attribute. See the attribute description for more information.	ViReal64
GlitchWidth	Specifies the glitch triggering glitch width in seconds. The driver uses this value to set the Glitch Width attribute. See the attribute description for more information.	ViReal64 (C/COM) PrecisionTimeSpan (.NET)
GlitchPolarity	Specifies the glitch polarity. The driver uses this value to set the Glitch Polarity attribute. See the attribute description for more information.	ViInt32
GlitchCondition	Specifies the glitch condition. The driver uses this value to set the Glitch Condition attribute. See the attribute description for more information.	ViInt32

Return Values (C/COM)

The *IVI-3.2: Inherent Capabilities Specification* defines general status codes that this function can return.

.NET Exceptions

The *IVI-3.2: Inherent Capabilities Specification* defines general exceptions that may be thrown, and warning events that may be raised, by this method.

8.4. IviScopeGlitchTrigger Behavior Model

The IviScopeGlitchTrigger group uses the behavior model defined by the IviScopeBase Capabilities.

8.5. IviScopeGlitchTrigger Compliance Notes

IVI Class-Compliant specific drivers that implement this extension group shall implement the Glitch Trigger value for the Trigger Type attribute in the IviScopeBase capabilities group.

9.IviScopeWidthTrigger Extension Group

9.1.IviScopeWidthTrigger Overview

In addition to the fundamental capabilities, the IviScopeWidthTrigger extension group defines extensions for oscilloscopes capable of triggering on user-specified pulse widths.

Width triggering occurs when the oscilloscope detects a positive or negative pulse with a width between, or optionally outside, the user-specified thresholds. The figure below shows positive and negative pulses that fall within the user-specified thresholds.

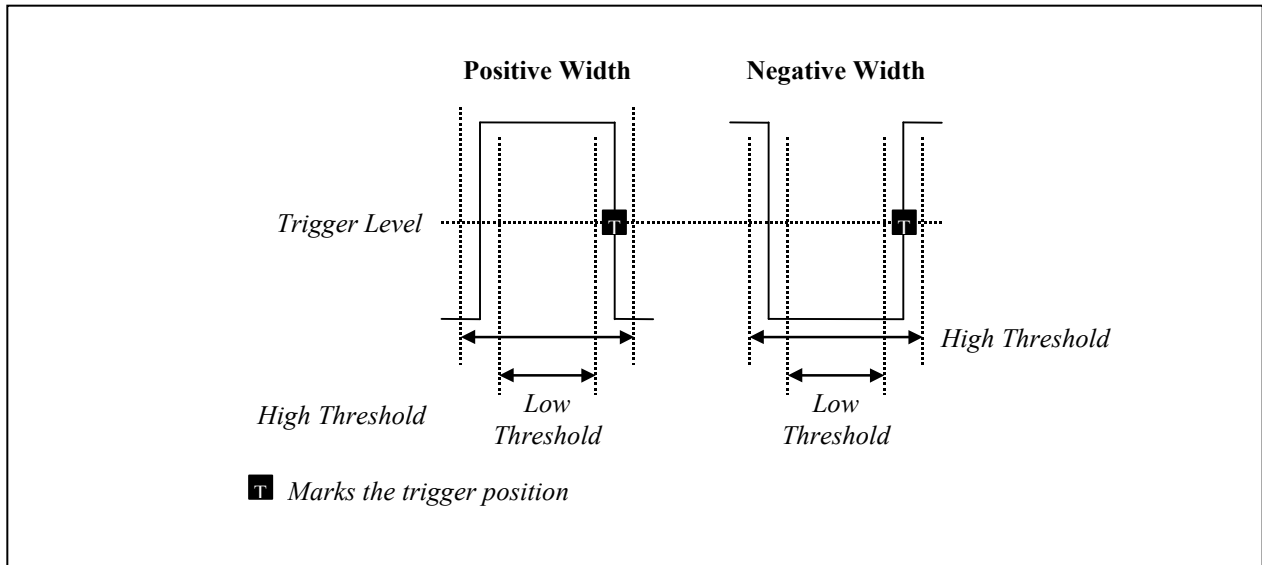

Figure 9-1. Width Triggers Within the Thresholds

The figure below shows positive and negative pulses that are not inside the user-specified thresholds.

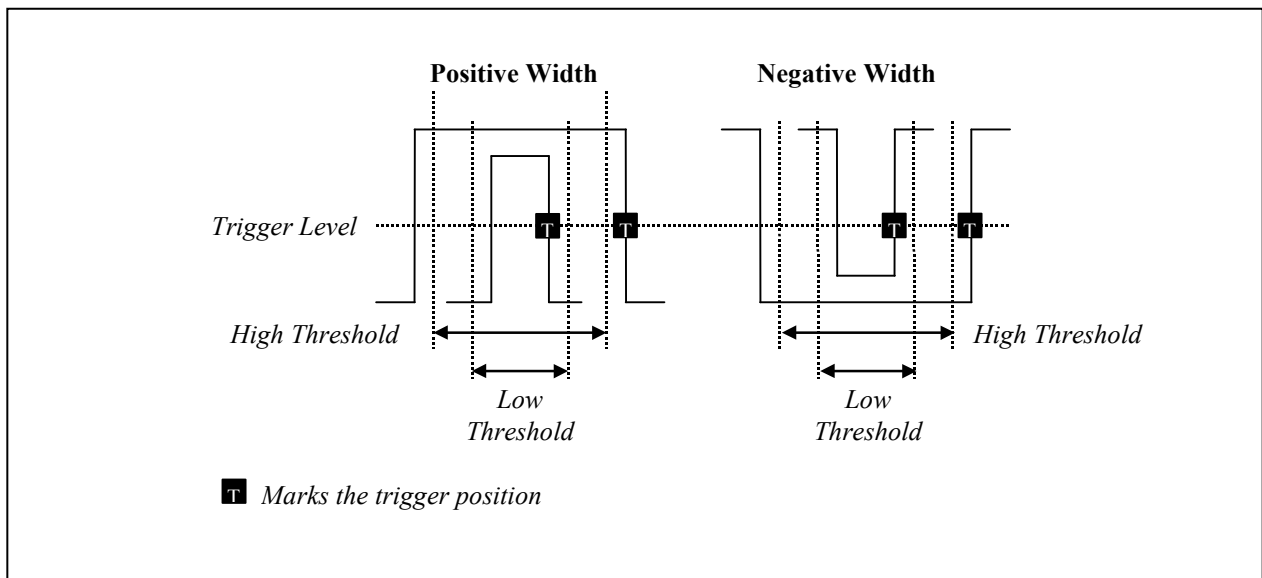

Figure 9-2. Width Triggers Outside the Thresholds

9.2.IviScopeWidthTrigger Attributes

The IviScopeWidthTrigger capability group defines the following attributes:

- Width Condition
- Width High Threshold
- Width Low Threshold
- Width Polarity

This section describes the behavior and requirements of each attribute. The actual value for each attribute ID is defined in Section 19, *IviScope Attribute ID Definitions*.

9.2.1.Width Condition

Data Type	Access	Applies to	Coercion	High Level Functions
ViInt32	R/W	N/A	None	Configure Width Trigger Source

.NET Property Name

`Trigger.Width.Condition`

.NET Enumeration Name

`WidthCondition`

COM Property Name

`Trigger.Width.Condition`

COM Enumeration Name

`IviScopeWidthConditionEnum`

C Constant Name

`IVISCOPE_ATTR_WIDTH_CONDITION`

Description

Specifies whether a pulse that is within or outside the high and low thresholds triggers the oscilloscope. The end-user specifies the high and low thresholds with the Width High Threshold and Width Low Threshold attributes.

Defined Values

<i>Name</i>	<i>Description</i>	
	<i>Language</i>	<i>Identifier</i>
Width Within	Configures the oscilloscope to trigger on pulses that have a width that is less than the high threshold and greater than the low threshold. The end-user specifies the high and low thresholds with the Width High Threshold and Width Low Threshold attributes.	
	.NET	<code>WidthCondition.Within</code>
	C	<code>IVISCOPE_VAL_WIDTH_WITHIN</code>
	COM	<code>IviScopeWidthConditionWithin</code>
Width Outside	Configures the oscilloscope to trigger on pulses that have a width that is either greater than the high threshold or less than a low threshold. The end-user specifies the high and low thresholds with the Width High Threshold and Width Low Threshold attributes.	
	.NET	<code>WidthCondition.Outside</code>
	C	<code>IVISCOPE_VAL_WIDTH_OUTSIDE</code>
	COM	<code>IviScopeWidthConditionOutside</code>

.NET Exceptions

The *IVI-3.2: Inherent Capabilities Specification* defines general exceptions that may be thrown, and warning events that may be raised, by this method.

9.2.2.Width High Threshold

Data Type	Access	Applies to	Coercion	High Level Functions
ViReal64 (C/COM)	R/W	N/A	None	Configure Width Trigger Source
Ivi.Driver.PrecisionTimeSpan (.NET)	R/W	N/A	None	Configure Width Trigger Source

.NET Property Name

`Trigger.Width.ThresholdHigh`

COM Property Name

`Trigger.Width.ThresholdHigh`

C Constant Name

`IVISCOPE_ATTR_WIDTH_HIGH_THRESHOLD`

Description

Specifies the high width threshold time. For C and COM, the units are seconds. For IVI.NET, the units are implicit in the definition of PrecisionTimeSpan.

.NET Exceptions

The *IVI-3.2: Inherent Capabilities Specification* defines general exceptions that may be thrown, and warning events that may be raised, by this method.

9.2.3.Width Low Threshold

Data Type	Access	Applies to	Coercion	High Level Functions
ViReal64 (C/COM)	R/W	N/A	None	Configure Width Trigger Source
Ivi.Driver.PrecisionTimeSpan (.NET)	R/W	N/A	None	Configure Width Trigger Source

.NET Property Name

`Trigger.Width.ThresholdLow`

COM Property Name

`Trigger.Width.ThresholdLow`

C Constant Name

`IVISCOPE_ATTR_WIDTH_LOW_THRESHOLD`

Description

Specifies the low width threshold time. For C and COM, the units are seconds. For IVI.NET, the units are implicit in the definition of PrecisionTimeSpan.

.NET Exceptions

The *IVI-3.2: Inherent Capabilities Specification* defines general exceptions that may be thrown, and warning events that may be raised, by this method.

9.2.4.Width Polarity

Data Type	Access	Applies to	Coercion	High Level Functions
ViInt32 (C/COM)	R/W	N/A	None	Configure Width Trigger Source
Polarity (.NET)	R/W	N/A	None	Configure Width Trigger Source

.NET Property Name

`Trigger.Width.Polarity`

.NET Enumeration Name

`Polarity`

COM Property Name

`Trigger.Width.Polarity`

COM Enumeration Name

`IviScopeWidthPolarityEnum`

C Constant Name

`IVISCOPE_ATTR_WIDTH_POLARITY`

Description

Specifies the polarity of the pulse that triggers the oscilloscope.

Defined Values

<i>Name</i>	<i>Description</i>	
	<i>Language</i>	<i>Identifier</i>
Width Positive	Configures the oscilloscope to trigger on positive pulses that have a width that meets the condition the user specifies with the Width Condition attribute.	
	.NET	Polarity.Positive
	C	IVISCOPE_VAL_WIDTH_POSITIVE
	COM	IviScopeWidthPolarityPositive
Width Negative	Configures the oscilloscope to trigger on negative pulses that have a width that meets the condition the user specifies with the Width Condition attribute.	
	.NET	Polarity.Negative
	C	IVISCOPE_VAL_WIDTH_NEGATIVE
	COM	IviScopeWidthPolarityNegative
Width Either	Configures the oscilloscope to trigger on either positive or negative pulses that have a width that meets the condition the user specifies with the Width Condition attribute.	
	.NET	Polarity.Either
	C	IVISCOPE_VAL_WIDTH_EITHER
	COM	IviScopeWidthPolarityEither

.NET Exceptions

The *IVI-3.2: Inherent Capabilities Specification* defines general exceptions that may be thrown, and warning events that may be raised, by this method.

9.3. IviScopeWidthTrigger Functions

The IviScopeWidthTrigger capability group defines the following function:

- Configure Width Trigger Source

This section describes the behavior and requirements of this function.

9.3.1. Configure Width Trigger Source

Description

This function configures the width trigger. A width trigger occurs when the oscilloscope detects a positive or negative pulse with a width between, or optionally outside, the width thresholds. The end-user specifies the width thresholds with the `WidthLowThreshold` and `WidthHighThreshold` parameters. The end-user specifies whether the oscilloscope triggers on pulse widths that are within or outside the width thresholds with the `WidthCondition` parameter. The end-user specifies the polarity of the pulse with the `WidthPolarity` parameter. The trigger does not actually occur until the edge of a pulse that corresponds to the `WidthLowThreshold`, `WidthHighThreshold`, `WidthCondition`, and `WidthPolarity` crosses the threshold the end-user specifies with the `TriggerLevel` parameter.

This function affects instrument behavior only if the trigger type is Width Trigger. Set the trigger type and trigger coupling before calling this function.

.NET Method Prototype

```
void Trigger.Width.Configure (String source,  
                             Double level,  
                             Ivi.Driver.PrecisionTimeSpan thresholdLow,  
                             Ivi.Driver.PrecisionTimeSpan thresholdHigh,  
                             Polarity polarity,  
                             WidthCondition condition);
```

COM Method Prototype

```
HRESULT Trigger.Width.Configure ([in] BSTR Source,  
                                 [in] DOUBLE Level,  
                                 [in] DOUBLE ThresholdLow,  
                                 [in] DOUBLE ThresholdHigh,  
                                 [in] IviScopeWidthPolarityEnum Polarity,  
                                 [in] IviScopeWidthConditionEnum Condition);
```

C Prototype

```
ViStatus IviScope_ConfigureWidthTriggerSource (ViSession Vi,  
                                               ViConstString Source,  
                                               ViReal64 Level,  
                                               ViReal64 WidthLowThreshold,  
                                               ViReal64 WidthHighTreshold,  
                                               ViInt32 WidthPolarity,  
                                               ViInt32 WidthCondition);
```

Parameters

Inputs	Description	Base Type
Vi	Instrument handle	ViSession
Source	Specifies the trigger source. The driver uses this value to set the Trigger Source attribute. See the attribute description for more information.	ViConstString
Level	Trigger Level. The driver uses this value to set the Trigger Level attribute. See the attribute description for more information.	ViReal64
WidthLowThreshold	Sets the width triggering low threshold in seconds. The driver uses this value to set the Width Low Threshold attribute. See the attribute description for more information.	ViReal64 (C/COM) PrecisionTimeSpan (.NET)
WidthHighThreshold	Sets the width triggering high threshold in seconds. The driver uses this value to set the Width High Threshold attribute. See the attribute description for more information.	ViReal64 (C/COM) PrecisionTimeSpan (.NET)
WidthPolarity	Sets the width polarity. The driver uses this value to set the Width Polarity attribute. See the attribute description for more information.	ViInt32
WidthCondition	Specifies whether a pulse that is within or outside the user-specified thresholds trigger waveform acquisition. The driver uses this value to set the Width Condition attribute. See the attribute description for more information.	ViInt32

Return Values (C/COM)

The *IVI-3.2: Inherent Capabilities Specification* defines general status codes that this function can return.

.NET Exceptions

The *IVI-3.2: Inherent Capabilities Specification* defines general exceptions that may be thrown, and warning events that may be raised, by this method.

9.4. IviScopeWidthTrigger Behavior Model

The IviScopeWidthTrigger group uses the behavior model defined by the IviScopeBase Capabilities.

9.5. IviScopeWidthTrigger Compliance Notes

IVI Class-Compliant specific drivers that implement this extension group shall implement the Width Trigger value for the Trigger Type attribute in the IviScopeBase capabilities group.

10. IviScopeAcLineTrigger Extension Group

10.1. IviScopeAcLineTrigger Overview

In addition to the fundamental capabilities, the IviScopeAcLineTrigger extension group defines extensions for oscilloscopes that are capable of synchronizing the trigger with the AC Line.

AC Line triggering occurs when the oscilloscope detects a positive zero crossing, negative zero crossing, or optionally either positive or negative zero crossing on the network supply voltage.

10.2. IviScopeAcLineTrigger Attributes

The IviScopeAcLineTrigger capability group defines the following attributes:

- AC Line Trigger Slope

This section describes the behavior and requirements of this attribute. The actual value for this attribute ID is defined in Section 19, *IviScope Attribute ID Definitions*.

10.2.1.AC Line Trigger Slope

Data Type	Access	Applies to	Coercion	High Level Functions
ViInt32	R/W	N/A	None	Configure AC Line Trigger Slope (IVI-C only)

.NET Property Name

`Trigger.ACLine.Slope`

.NET Enumeration Name

`ACLineSlope`

COM Property Name

`Trigger.ACLine.Slope`

COM Enumeration Name

`IviScopeACLineSlopeEnum`

C Constant Name

`IVISCOPE_ATTR_AC_LINE_TRIGGER_SLOPE`

Description

Specifies the slope of the zero crossing upon which the scope triggers.

Defined Values

<i>Name</i>	<i>Description</i>	
	<i>Language</i>	<i>Identifier</i>
AC Line Positive	Configures the oscilloscope to trigger on positive slope zero crossings of the network supply voltage.	
	.NET	ACLineSlope.Positive
	C	IVISCOPE_VAL_AC_LINE_POSITIVE
	COM	IviScopeACLinePositive
AC Line Negative	Configures the oscilloscope to trigger on negative slope zero crossings of the network supply voltage.	
	.NET	ACLineSlope.Negative
	C	IVISCOPE_VAL_AC_LINE_NEGATIVE
	COM	IviScopeACLineNegative
AC Line Either	Configures the oscilloscope to trigger on either positive or negative slope zero crossings of the network supply voltage.	
	.NET	ACLineSlope.Either
	C	IVISCOPE_VAL_AC_LINE_EITHER
	COM	IviScopeACLineEither

.NET Exceptions

The *IVI-3.2: Inherent Capabilities Specification* defines general exceptions that may be thrown, and warning events that may be raised, by this method.

Compliance Notes

The driver shall implement the AC Line Either value for this attribute.

10.3. IviScopeAcLineTrigger Functions

The IviScopeAcLineTrigger capability group defines the following function:

- Configure AC Line Trigger Slope (IVI-C only)

This section describes the behavior and requirements of this function.

10.3.1. Configure AC Line Trigger Slope (IVI-C only)

Description

This function configures the slope of the AC Line trigger.

This function affects instrument behavior only if the trigger type is AC Line Trigger. Call the Configure Trigger function to set the trigger type before calling this function.

.NET Method Prototype

N/A
(use the `Trigger.ACLine.Slope` property)

COM Method Prototype

N/A
(use the `Trigger.ACLine.Slope` property)

C Prototype

```
ViStatus IviScope_ConfigureAcLineTriggerSlope (ViSession Vi,  
                                               ViInt32 ACLineSlope);
```

Parameters

Inputs	Description	Base Type
Vi	Instrument handle	ViSession
ACLineSlope	Specifies whether an oscilloscope triggers on a zero crossing with a positive, negative, or either slope of the network supply voltage. The driver uses this value to set the AC Line Trigger Slope attribute. See the attribute description for more information	ViInt32

Return Values (C)

The *IVI-3.2: Inherent Capabilities Specification* defines general status codes that this function can return.

10.4. IviScopeAcLineTrigger Behavior Model

The IviScopeAcLineTrigger group uses the behavior model defined by the IviScopeBase Capabilities.

10.5. IviScopeAcLineTrigger Compliance Notes

IVI Class-Compliant specific drivers that implement this extension group shall implement the AC Line Trigger value for the Trigger Type attribute in the IviScopeBase capabilities group.

11.IviScopeWaveformMeasurement Extension Group

11.1.IviScopeWaveformMeasurement Overview

The IviScopeWaveformMeasurement extension group defines extensions for oscilloscopes capable of calculating various measurements such as rise-time, fall-time, period, and frequency from an acquired waveform. In .NET, see the Fetch Waveform Measurement and Read Waveform Measurement methods for an explanation of the differences between measurement functions and time measurement enumerations.

Table 111. Waveform Measurement Descriptions





Name	Description	
	Language	Identifier
 Rise Time	The length of time for a rising edge of the signal to rise from the low reference level to the high reference level. The units are seconds.	
	.NET	MeasurementFunction.RiseTime TimeMeasurementFunction.RiseTime
	C	IVISCOPE_VAL_RISE_TIME
	COM	IviScopeMeasurementRiseTime
 Fall Time	The length of time for a falling edge of the signal to fall from the high reference level to the low reference level. The units are seconds.	
	.NET	MeasurementFunction.FallTime TimeMeasurementFunction.FallTime
	C	IVISCOPE_VAL_FALL_TIME
	COM	IviScopeMeasurementFallTime
 Frequency	The frequency of one complete cycle in the waveform. The units are hertz.	
	.NET	MeasurementFunction.Frequency
	C	IVISCOPE_VAL_FREQUENCY
	COM	IviScopeMeasurementFrequency
 Period	The length of time of one complete cycle in the waveform. The units are seconds.	
	.NET	MeasurementFunction.Period TimeMeasurementFunction.Period
	C	IVISCOPE_VAL_PERIOD
	COM	IviScopeMeasurementPeriod
 Voltage Rms	The true Root Mean Square voltage of the entire waveform. The units are volts.	
	.NET	MeasurementFunction.VoltageRms
	C	IVISCOPE_VAL_VOLTAGE_RMS
	COM	IviScopeMeasurementVoltageRms

Table 111. Waveform Measurement Descriptions







Name	Description	
	Language	Identifier
 Voltage Cycle RMS	The true Root Mean Square voltage over an integer number of cycles in the waveform. The units are volts.	
	.NET	MeasurementFunction.VoltageCycleRms
	C	IVISCOPE_VAL_VOLTAGE_CYCLE_RMS
	COM	IviScopeMeasurementVoltageCycleRms
 Voltage Max	The maximum amplitude found in the entire waveform. The units are volts.	
	.NET	MeasurementFunction.VoltageMaximum
	C	IVISCOPE_VAL_VOLTAGE_MAX
	COM	IviScopeMeasurementVoltageMax
 Voltage Min	The minimum amplitude found in the entire waveform. The units are volts.	
	.NET	MeasurementFunction.VoltageMinimum
	C	IVISCOPE_VAL_VOLTAGE_MIN
	COM	IviScopeMeasurementVoltageMin
 Voltage Peak To Peak	The absolute difference between the VOLTAGE_MAX and the VOLTAGE_MIN. The units are volts.	
	.NET	MeasurementFunction.VoltagePeakToPeak
	C	IVISCOPE_VAL_VOLTAGE_PEAK_TO_PEAK
	COM	IviScopeMeasurementVoltagePeakToPeak
 Voltage High	The voltage that corresponds to 100% when using the reference levels. The oscilloscope calculates this value using either the min/max or histogram methods. The min/max method uses the maximum value found. The histogram method uses a common value found above the middle of the waveform. The units are volts.	
	.NET	MeasurementFunction.VoltageHigh
	C	IVISCOPE_VAL_VOLTAGE_HIGH
	COM	IviScopeMeasurementVoltageHigh
 Voltage Low	The voltage that corresponds to 0% when using the reference levels. The oscilloscope calculates this value using either the min/max or histogram methods. The min/max method uses the minimum value found. The histogram method uses a common value found below the middle of the waveform. The units are volts.	
	.NET	MeasurementFunction.VoltageLow
	C	IVISCOPE_VAL_VOLTAGE_LOW



Table 111. Waveform Measurement Descriptions



Name	Description	
	Language	Identifier
	COM	IviScopeMeasurementVoltageLow
 Voltage Average	The arithmetic average in volts measured over the entire waveform. The units are volts.	
	.NET	MeasurementFunction.VoltageAverage
	C	IVISCOPE_VAL_VOLTAGE_AVERAGE
	COM	IviScopeMeasurementVoltageAverage
 Voltage Cycle Average	The arithmetic average in volts over an integer number of cycles in the waveform. The units are volts.	
	.NET	MeasurementFunction.VoltageCycleAverage
	C	IVISCOPE_VAL_VOLTAGE_CYCLE_AVERAGE
	COM	IviScopeMeasurementVoltageCycleAverage
Width Negative	The length of time between the mid reference level points of a negative pulse in the waveform. The units are seconds.	
	.NET	MeasurementFunction.WidthNegative TimeMeasurementFunction.WidthNegative
	C	IVISCOPE_VAL_WIDTH_NEG
	COM	IviScopeMeasurementWidthNeg
 Width Positive	The length of time between the mid reference level points of a positive pulse in the waveform. The units are seconds.	
		MeasurementFunction.WidthPositive TimeMeasurementFunction.WidthPositive
	C	IVISCOPE_VAL_WIDTH_POS
	COM	IviScopeMeasurementWidthPos
Duty Cycle Negative	The ratio of the WIDTH_NEG to the PERIOD of an integer number of cycles in the waveform expressed as a percentage.	
	$DUTY_CYCLE_NEG = \frac{WIDTH_NEG}{PERIOD} \times 100\%$	
	.NET	MeasurementFunction.DutyCycleNegative
	C	IVISCOPE_VAL_DUTY_CYCLE_NEG
Duty Cycle Positive	The ratio of the WIDTH_POS width to the PERIOD of an integer number of cycles in the waveform expressed as a percentage.	
	$DUTY_CYCLE_POS = \frac{WIDTH_POS}{PERIOD} \times 100\%$	
	.NET	MeasurementFunction.DutyCyclePositive
	C	IVISCOPE_VAL_DUTY_CYCLE_POS

Table 111. Waveform Measurement Descriptions



Name	Description	
	Language	Identifier
	.NET	MeasurementFunction.DutyCyclePositive
	C	IVISCOPE_VAL_DUTY_CYCLE_POS
	COM	IviScopeMeasurementDutyCyclePos
 Amplitude	The VOLTAGE_HIGH less the VOLTAGE_LOW in volts over the entire waveform $AMPLITUDE = VOLTAGE_HIGH - VOLTAGE_LOW$	
	.NET	MeasurementFunction.Amplitude
	C	IVISCOPE_VAL_AMPLITUDE
	COM	IviScopeMeasurementAmplitude
 Overshoot	The relative waveform distortion that follows an edge transition. It is calculated using the following formula: -for the rising edge $OVERSHOOT = \frac{\text{local maximum} - VOLTAGE_HIGH}{AMPLITUDE} \times 100\%$ where the local maximum is the maximum voltage of the signal in the first half of the time period that commences when the rising edge crosses the high reference level and concludes when the subsequent falling edge crosses the high reference level. -for the falling edge: $OVERSHOOT = \frac{VOLTAGE_LOW - \text{local minimum}}{AMPLITUDE} \times 100\%$ where the local minimum is the minimum value of the signal measured in the first half of the time period that commences when the falling edge crosses the low reference level and concludes when the subsequent rising edge crosses the low reference level. The instrument makes the measurement on the edge closest to the beginning of the waveform record. The units are the percentage of the signal amplitude.	
	.NET	MeasurementFunction.Overshoot
	C	IVISCOPE_VAL_OVERSHOOT
	COM	IviScopeMeasurementOvershoot

Table 111. Waveform Measurement Descriptions

Name	Description	
	Language	Identifier
 Preshoot	<p>The relative waveform distortion that precedes an edge transition. It is calculated using the following formula:</p> <p>-for the rising edge</p> $\text{PRESHOOT} = \frac{\text{VOLTAGE_LOW} - \text{local minimum}}{\text{AMPLITUDE}} \times 100\%$ <p>where the local minimum is the minimum value of the signal measured in the second half of the time period that commences when the preceding falling edge crosses the low reference level and concludes when the rising edge crosses the low reference level.</p> <p>-for the falling edge:</p> $\text{PRESHOOT} = \frac{\text{local maximum} - \text{VOLTAGE_HIGH}}{\text{AMPLITUDE}} \times 100\%$ <p>where the local maximum is the maximum voltage of the signal in the second half of the time period that commences when the preceding rising edge crosses the high reference level and concludes when the falling edge crosses the high reference level.</p> <p>The instrument makes the measurement on the edge closest to the beginning of the waveform record. The units are the percentage of the signal amplitude.</p>	
	.NET	MeasurementFunction.Preshoot
	C	IVISCOPE_VAL_PRESHOOT
	COM	IviScopeMeasurementPreshoot

11.2. IviScopeWaveformMeasurement Attributes

The IviScopeWaveformMeasurement capability group defines the following attributes:

- Measurement High Reference
- Measurement Low Reference
- Measurement Middle Reference

This section describes the behavior and requirements of each attribute. The actual value for each attribute ID is defined in Section 19, *IviScope Attribute ID Definitions*.

11.2.1.Measurement High Reference

Data Type	Access	Applies to	Coercion	High Level Functions
ViReal64	R/W	N/A	None	Configure Reference Levels

.NET Property Name

ReferenceLevel.High

COM Property Name

ReferenceLevel.High

C Constant Name

IVISCOPE_ATTR_MEAS_HIGH_REF

Description

Specifies the high reference the oscilloscope uses for waveform measurements. The value is a percentage of the difference between the Voltage High and Voltage Low.

.NET Exceptions

The *IVI-3.2: Inherent Capabilities Specification* defines general exceptions that may be thrown, and warning events that may be raised, by this method.

Compliance Notes

Since measurements depend on this value, the driver shall not perform any coercion of this value, but report an invalid configuration error if the instrument cannot be programmed to a desired value.

11.2.2.Measurement Low Reference

Data Type	Access	Applies to	Coercion	High Level Functions
ViReal64	R/W	N/A	None	Configure Reference Levels

.NET Property Name

ReferenceLevel.Low

COM Property Name

ReferenceLevel.Low

C Constant Name

IVISCOPE_ATTR_MEAS_LOW_REF

Description

Specifies the low reference the oscilloscope uses for waveform measurements. The value is a percentage of the difference between the Voltage High and Voltage Low.

.NET Exceptions

The *IVI-3.2: Inherent Capabilities Specification* defines general exceptions that may be thrown, and warning events that may be raised, by this method.

Compliance Notes

Since measurements depend on this value, the driver shall not perform any coercion of this value, but report an invalid configuration error if the instrument cannot be programmed to a desired value.

11.2.3.Measurement Middle Reference

Data Type	Access	Applies to	Coercion	High Level Functions
ViReal64	R/W	N/A	None	Configure Reference Levels

.NET Property Name

ReferenceLevel.Middle

COM Property Name

ReferenceLevel.Mid

C Constant Name

IVISCOPE_ATTR_MEAS_MID_REF

Description

Specifies the middle reference the oscilloscope uses for waveform measurements. The value is a percentage of the difference between the Voltage High and Voltage Low.

.NET Exceptions

The *IVI-3.2: Inherent Capabilities Specification* defines general exceptions that may be thrown, and warning events that may be raised, by this method.

Compliance Notes

Since measurements depend on this value, the driver shall not perform any coercion of this value, but report an invalid configuration error if the instrument cannot be programmed to a desired value.

11.3. IviScopeWaveformMeasurement Functions

The IviScopeWaveformMeasurement capability group defines the following functions:

- Configure Reference Levels
- Fetch Waveform Measurement
- Read Waveform Measurement

This section describes the behavior and requirements of each function.

11.3.1. Configure Reference Levels

Description

This function configures the reference levels for waveform measurements. Call this function before calling the Read Waveform Measurement or Fetch Waveform Measurement to take waveform measurements.

.NET Method Prototype

```
void ReferenceLevel.Configure (Double low,  
                              Double middle,  
                              Double high);
```

COM Method Prototype

```
HRESULT ReferenceLevel.Configure ([in] DOUBLE Low,  
                                 [in] DOUBLE Mid,  
                                 [in] DOUBLE High);
```

C Prototype

```
ViStatus IviScope_ConfigureRefLevels (ViSession Vi,  
                                       ViReal64 Low,  
                                       ViReal64 Mid,  
                                       ViReal64 High);
```

Parameters

Inputs	Description	Base Type
Vi	Instrument handle	ViSession
Low	Measurement low reference. The driver uses this value to set the Meas Low Ref attribute. See the attribute description for more information.	ViReal64
Mid (C/COM) middle (.NET)	Measurement mid reference. The driver uses this value to set the Meas Mid Ref attribute. See the attribute description for more information.	ViReal64
High	Measurement high reference. The driver uses this value to set the Meas High Ref attribute. See the attribute description for more information.	ViReal64

Return Values (C/COM)

The *IVI-3.2: Inherent Capabilities Specification* defines general status codes that this function can return.

.NET Exceptions

The *IVI-3.2: Inherent Capabilities Specification* defines general exceptions that may be thrown, and warning events that may be raised, by this method.

11.3.2.Fetch Waveform Measurement

Description

This function fetches a specified waveform measurement from a specific channel from a previously initiated waveform acquisition. If the channel is not enabled for the acquisition, this function returns the Channel Not Enabled error.

This function obtains a waveform measurement and returns the measurement value. The end-user specifies a particular measurement type, such as rise time, frequency, and voltage peak-to-peak. The waveform on which the oscilloscope calculates the waveform measurement is from an acquisition that was previously initiated.

Use the Initiate Acquisition function to start an acquisition on the channels that were enabled with the Configure Channel function. The oscilloscope acquires waveforms for the enabled channels concurrently. Use the Acquisition Status function to determine when the acquisition is complete. Call this function separately for each waveform measurement on a specific channel.

The end-user can call the Read Waveform Measurement function instead of the Initiate Acquisition function. The Read Waveform Measurement function starts an acquisition on all enabled channels. It then waits for the acquisition to complete, obtains a waveform measurement on the specified channel, and returns the measurement value. Call this function separately to obtain any other waveform measurements on a specific channel.

Configure the appropriate reference levels before calling this function to take a rise time, fall time, width negative, width positive, duty cycle negative, or duty cycle positive measurement.

The end-user can configure the low, mid, and high references either by calling the Configure Reference Levels function or by setting the following attributes.

- Measurement High Reference
- Measurement Low Reference
- Measurement Mid Reference

This function does not check the instrument status. Typically, the end-user calls this function only in a sequence of calls to other low-level driver functions. The sequence performs one operation. The end-user uses the low-level functions to optimize one or more aspects of interaction with the instrument. Call the Error Query function at the conclusion of the sequence to check the instrument status.

.NET Method Prototype

```
Double Channels[].Measurement.FetchWaveformMeasurement (
    MeasurementFunction measurementFunction);
```

```
PrecisionTimeSpan Channels[].Measurement.FetchWaveformMeasurement (
    TimeMeasurementFunction measurementFunction);
```

COM Method Prototype

```
HRESULT Measurements.Item().FetchWaveformMeasurement (
    [in] IviScopeMeasurementEnum MeasFunction,
    [in,out] DOUBLE Measurement);
```

C Prototype

```
ViStatus IviScope_FetchWaveformMeasurement (ViSession Vi,
    ViConstString Channel
    ViInt32 MeasFunction,
    ViReal64 *Measurement);
```

Parameters

Inputs	Description	Base Type
Vi	Instrument handle	ViSession
Channel	Name of the channel from which to read a waveform.	ViConstString
MeasFunction (C/COM)	Characteristic of the acquired waveform to be measured.	ViInt32
measurementFunction (.NET)	Characteristic of the acquired waveform to be measured.	MeasurementFunction
	Time-related characteristic of the acquired waveform to be measured.	TimeMeasurementFunction

Outputs	Description	Base Type
Measurement (C/COM)	The measured value. The units depend on the measurement that the user specifies with the measFunction parameter.	ViReal64
Return Value (.NET)	The measured value. The units depend on the measurement that the user specifies with the measFunction parameter.	Double
	The measured value. The time units are inherent in the PrecisionTimeSpan class.	PrecisionTimeSpan

Defined Values for Measurement Function

Refer to Table 111. Waveform Measurement Descriptions for the list of defined values for the MeasFunction parameter.

Return Values (C/COM)

The *IVI-3.2: Inherent Capabilities Specification* defines general status codes that this function can return. The table below specifies additional class-defined status codes for this function.

Completion Codes	Description
Unable To Perform Measurement	Error: Unable to perform desired waveform measurement operation.
Channel Not Enabled	Error: Specified channel is not enabled for acquisition.

.NET Exceptions

The *IVI-3.2: Inherent Capabilities Specification* defines general exceptions that may be thrown, and warning events that may be raised, by this method.

The table below specifies additional class-defined exceptions for this method.

Exception Class	Description
UnableToPerformMeasurementException	Unable to perform desired waveform measurement operation.

ChannelNotEnabledException	Specified channel is not enabled for acquisition.
----------------------------	---

Compliance Notes

1. If an IVI-C class driver defines additional values for the `measFunction` parameter, the actual values shall be greater than or equal to `IVISCOPE_VAL_MEASUREMENT_FUNCTION_CLASS_EXT_BASE` and less than `IVISCOPE_VAL_MEASUREMENT_FUNCTION_SPECIFIC_EXT_BASE`.
2. If an IVI-C specific driver defines additional values for this parameter, the actual values shall be greater than or equal to `IVISCOPE_VAL_MEASUREMENT_FUNCTION_SPECIFIC_EXT_BASE`.
3. If an IVI-COM specific driver implements this method with additional values for the `measFunction` parameter in its instrument specific interfaces, the actual values of the additional elements shall be greater than or equal to Measurement Function Specific Ext Base.

See Section 21, *IviScope Function Parameter Value Definitions*, for the definitions of Measurement Function Specific Ext Base, `IVISCOPE_VAL_MEASUREMENT_FUNCTION_SPECIFIC_EXT_BASE` and `IVISCOPE_VAL_MEASUREMENT_FUNCTION_CLASS_EXT_BASE`.

11.3.3.Read Waveform Measurement

Description

This function initiates a new waveform acquisition and returns a specified waveform measurement from a specific channel.

This function initiates an acquisition on the channels that the end-user enables with the Configure Channel function. If the channel is not enabled for the acquisition, this function returns Channel Not Enabled error. It then waits for the acquisition to complete, obtains a waveform measurement on the channel the end-user specifies, and returns the measurement value. The end-user specifies a particular measurement type, such as rise time, frequency, and voltage peak-to-peak.

If the oscilloscope did not complete the acquisition within the time period the user specified with the `MaxTimeMilliseconds` parameter, the function returns the Max Time Exceeded error.

The end-user can call the Fetch Waveform Measurement function separately to obtain any other waveform measurement on a specific channel without initiating another acquisition.

The end-user must configure the appropriate reference levels before calling this function. Configure the low, mid, and high references either by calling the Configure Reference Levels function or by setting the following attributes.

- Measurement High Reference
- Measurement Low Reference
- Measurement Middle Reference

.NET Method Prototype

```
Double Channels[].Measurement.ReadWaveformMeasurement (
    MeasurementFunction measurementFunction,
    PrecisionTimeSpan maximumTime);

PrecisionTimeSpan Channels[].Measurement.ReadWaveformMeasurement (
    TimeMeasurementFunction measurementFunction,
    PrecisionTimeSpan maximumTime);
```

COM Method Prototype

```
HRESULT Measurements.Item().ReadWaveformMeasurement (
    [in] IviScopeMeasurementEnum MeasFunction,
    [in] LONG MaxTimeMilliseconds,
    [in,out] DOUBLE Measurement);
```

C Prototype

```
ViStatus IviScope_ReadWaveformMeasurement (ViSession Vi,
    ViConstString Channel,
    ViInt32 MeasFunction,
    ViInt32 MaxTimeMilliseconds,
    ViReal64 *Measurement);
```

Parameters

Inputs	Description	Base Type
Vi	Instrument handle	ViSession
Channel	Name of the channel from which to read a waveform.	ViConstString
MeasFunction (C/COM)	Characteristic of the acquired waveform to be measured.	ViInt32
measurementFunction (.NET)	Characteristic of the acquired waveform to be measured.	MeasurementFunction
	Time-related characteristic of the acquired waveform to be measured.	TimeMeasurementFunction
MaxTimeMilliseconds (C/COM)	Specifies the maximum time the end-user allows for this function to complete in milliseconds. Defined values: Max Time Immediate - The function returns immediately. If no valid measurement value exists, the function returns an error. Max Time Infinite - The function waits indefinitely for the measurement to complete.	ViInt32
maximumTime (.NET)	Specifies the maximum time the end-user allows for this function to complete in milliseconds. Defined values: TimeSpan.Zero - The function returns immediately. If no valid measurement value exists, the function returns an error. TimeSpan.MaxValue - The function waits indefinitely for the measurement to complete.	PrecisionTimeSpan

Outputs	Description	Base Type
Measurement (C/COM)	The measured value. The units depend on the measurement that the user specifies with the measFunction parameter.	ViReal64
Return Value (.NET)	The measured value. The units depend on the measurement that the user specifies with the measFunction parameter.	Double
	The measured value. The time units are inherent in the PrecisionTimeSpan class.	PrecisionTimeSpan

Defined Values for the MaxTimeMilliseconds Parameter (IVI-C & IVI-COM Only)

<i>Name</i>	<i>Description</i>	
	<i>Language</i>	<i>Identifier</i>
Max Time Immediate	The function returns immediately. If no valid measurement value exists, the function returns an error.	
	C	IVISCOPE_VAL_MAX_TIME_IMMEDIATE
	COM	IviScopeTimeOutImmediate
Max Time Infinite	The function waits indefinitely for the measurement to complete.	
	C	IVISCOPE_VAL_MAX_TIME_INFINITE
	COM	IviScopeTimeOutInfinite

Defined Values for the maximumTime Parameter (IVI.NET Only)

<i>Name</i>	<i>Description</i>	
	<i>Language</i>	<i>Identifier</i>
Zero	The function returns immediately. If no valid measurement value exists, the function returns an error.	
	.NET	TimeSpan.Zero
Max Value	The function waits indefinitely for the measurement to complete.	
	.NET	TimeSpan.MaxValue

Defined Values for Measurement Function

Refer to Table 111. Waveform Measurement Descriptions for the list of defined values for the MeasFunction parameter.

Return Values (C/COM)

The *IVI-3.2: Inherent Capabilities Specification* defines general status codes that this function can return. The table below specifies additional class-defined status codes for this function.

Completion Codes	Description
Channel Not Enabled	Error: Specified channel is not enabled for acquisition.
Max Time Exceeded	Error: Maximum time exceeded before the operation completed.
Unable To Perform Measurement	Error: Unable to perform desired waveform measurement operation.

.NET Exceptions

The *IVI-3.2: Inherent Capabilities Specification* defines general exceptions that may be thrown, and warning events that may be raised, by this method.

The table below specifies additional class-defined exceptions for this method.

Exception Class	Description
UnableToPerformMeasurementException	Unable to perform desired waveform measurement operation.
ChannelNotEnabledException	Specified channel is not enabled for acquisition.

Note that the .NET `MaxTimeExceededException` is defined in *IVI-3.2: Inherent Capabilities Specification*.

Compliance Notes

1. The specific instrument driver is not required to support any of the defined values for the `MaxTimeMilliseconds` parameter.
2. If an IVI-C class driver defines additional values for the `measFunction` parameter, the actual values shall be greater than or equal to `IVISCOPE_VAL_MEASUREMENT_FUNCTION_CLASS_EXT_BASE` and less than `IVISCOPE_VAL_MEASUREMENT_FUNCTION_SPECIFIC_EXT_BASE`.
3. If an IVI-C specific driver defines additional values for this parameter, the actual values shall be greater than or equal to `IVISCOPE_VAL_MEASUREMENT_FUNCTION_SPECIFIC_EXT_BASE`.
4. If an IVI-COM specific driver implements this method with additional values for the `measFunction` parameter in its instrument specific interfaces, the actual values of the additional elements shall be greater than or equal to Measurement Function Specific Ext Base.

See Section 21, *IviScope Function Parameter Value Definitions*, for the definitions of Measurement Function Specific Ext Base, `IVISCOPE_VAL_MEASUREMENT_FUNCTION_SPECIFIC_EXT_BASE` and `IVISCOPE_VAL_MEASUREMENT_FUNCTION_CLASS_EXT_BASE`.

11.4. IviScopeWaveformMeasurement Behavior Model

The IviScopeWaveformMeasurement group uses the behavior model defined by the IviScopeBase Capabilities.

12.IviScopeMinMaxWaveform Extension Group

12.1.IviScopeMinMaxWaveform Overview

The IviScopeMinMaxWaveform extension group provides support for oscilloscopes that can acquire minimum and maximum waveforms that correspond to the same range of time. The two most common acquisition types in which oscilloscopes return minimum and maximum waveforms are envelope and peak detect.

12.2.IviScopeMinMaxWaveform Attributes

The IviScopeMinMaxWaveform capability group defines the following attribute:

- Number of Envelopes

This section describes the behavior and requirements of this attribute. The actual value for this attribute ID is defined in Section 19, *IviScope Attribute ID Definitions*.

12.2.1. Number of Envelopes

Data Type	Access	Applies to	Coercion	High Level Functions
ViInt32	R/W	N/A	None	Configure Number of Envelopes (IVI-C only)

.NET Property Name

`Acquisition.NumberOfEnvelopes`

COM Property Name

`Acquisition.NumberOfEnvelopes`

C Constant Name

`IVISCOPE_ATTR_NUM_ENVELOPES`

Description

When the end-user sets the Acquisition Type attribute to Envelope, the oscilloscope acquires multiple waveforms. After each waveform acquisition, the oscilloscope keeps the minimum and maximum values it finds for each point in the waveform record. This attribute specifies the number of waveforms the oscilloscope acquires and analyzes to create the minimum and maximum waveforms. After the oscilloscope acquires as many waveforms as this attribute specifies, it returns to the idle state. This attribute affects instrument operation only when the Acquisition Type attribute is set to Envelope.

.NET Exceptions

The *IVI-3.2: Inherent Capabilities Specification* defines general exceptions that may be thrown, and warning events that may be raised, by this method.

12.3. IviScopeMinMaxWaveform Functions

The IviScopeMinMaxWaveform capability group defines the following functions:

- Configure Number of Envelopes (IVI-C Only)
- Fetch Min Max Waveform
- Read Min Max Waveform

This section describes the behavior and requirements of each function.

12.3.1. Configure Number of Envelopes (IVI-C Only)

Description

This function configures the number of waveforms the oscilloscope acquires and analyzes to create the minimum and maximum waveforms.

When the acquisition type is set to Envelope, the oscilloscope acquires multiple waveforms. After each waveform acquisition, the oscilloscope keeps the minimum and maximum values it finds for each element in the waveform record. This function configures the number of waveforms the oscilloscope acquires and analyzes to create the minimum and maximum waveforms.

After the oscilloscope acquires the specified number of waveforms, it returns to the idle state.

Set the acquisition type to Envelope before calling this function.

.NET Method Prototype

N/A
(use the `Acquisition.NumberOfEnvelopes` property)

COM Method Prototype

N/A
(use the `Acquisition.NumberOfEnvelopes` property)

C Prototype

```
ViStatus IviScope_ConfigureNumEnvelopes (ViSession Vi,  
                                          ViInt32 NumEnvelopes);
```

Parameters

Inputs	Description	Base Type
Vi	Instrument handle	ViSession
NumEnvelopes	Specifies the number of waveforms the oscilloscope acquires and analyzes to create the minimum and maximum waveforms. The driver sets the Number of Envelopes attribute to this value. See the Number of Envelopes attribute for a complete description.	ViInt32

Return Values (C)

The *IVI-3.2: Inherent Capabilities Specification* defines general status codes that this function can return.

12.3.2. Fetch Min Max Waveform

Description

This function returns the minimum and maximum waveforms that the oscilloscope acquires for the specified channel. If the channel is not enabled for the acquisition, this function returns the Channel Not Enabled error.

The waveforms are from a previously initiated acquisition. Use this function to fetch waveforms when the acquisition type is set to Peak Detect or Envelope. If the acquisition type is not one of the listed types, the function returns the Invalid Acquisition Type error.

Use the Initiate Acquisition function to start an acquisition on the enabled channels. The oscilloscope acquires the min/max waveforms for the enabled channels concurrently. Use the Acquisition Status function to determine when the acquisition is complete. The end-user must call this function separately for each enabled channel to obtain the min/max waveforms.

The end-user can call the Read Min Max Waveform function instead of the Initiate Acquisition function. The Read Min Max Waveform function starts an acquisition on all enabled channels, waits for the acquisition to complete, and returns the min/max waveforms for the specified channel. You call this function to obtain the min/max waveforms for each of the remaining channels.

After this function executes, each element in the `MinWaveform` and `MaxWaveform` parameters is either a voltage or a value indicating that the oscilloscope could not sample a voltage.

The behavior is different for IVI-C/IVI-Com and IVI.NET as follows:

IVI-C/IVI-COM: After this function executes, each element in the `waveformArray` parameter is either a voltage or a value indicating that the oscilloscope could not sample a voltage.

IVI.NET: For .NET the return value of `IWaveform<T>` is a waveform object. Refer to Section 4, *Common Properties and Methods of Waveform and Spectrum Interfaces*, and Section 5, *IWaveform<T> Interface*, of *IVI-3.2: Inherent Capabilities Specification*, for the definition of the `IWaveform` object and information regarding its use. In particular, refer to Section 4.2, *How to use Waveform and Spectrum Types*, in *IVI-3.18: IVI.NET Utility Classes and Interfaces Specification*, for more information about how to implement these methods.

For all uses of `WaveformMinMax<T>`, the `InitialX`, `XIncrement`, and array sizes must match for both min and max waveforms.

The C end-user configures the interpolation method the oscilloscope uses with the `IviScope_ConfigureInterpolation` function. The COM end-user uses the `Acquisition.Interpolation` property. If interpolation is disabled, the oscilloscope does not interpolate points in the waveform. If the oscilloscope cannot sample a value for a point in the waveform, the driver sets the corresponding element in the `MinWaveform` or `MaxWaveform` to an IEEE-defined NaN (Not a Number) value and the function returns the Invalid Waveform Element warning. For C and COM, the function returns the Invalid Waveform Element warning. For .NET, the `IWaveform` return value includes a property that indicates if there is an invalid waveform element.

For C and COM, use the `Is Waveform Element Invalid` function to test each element in the `waveformArray` parameter for an invalid waveform element. For .NET, check for `Double.IsNaN` if the waveform is of type `Double`.

This function does not check the instrument status. Typically, the end-user calls this function only in a sequence of calls to other low-level driver functions. The sequence performs one operation. The end-user uses the low-level functions to optimize one or more aspects of interaction with the instrument. Call the `Error Query` function at the conclusion of the sequence to check the instrument status.

.NET MinMax Waveform Struct

```
Struct MinMaxWaveform<T>
{
    Public MinMaxWaveform(IWaveform<T> minWaveform, IWaveform<T> maxWaveform);
    public IWaveform<T> MinWaveform { get; }
    public IWaveform<T> MaxWaveform { get; }
}
```

.NET Method Prototype

```
MinMaxWaveform<Double> Channels[].Measurement.FetchWaveformMinMax (
    MinMaxWaveform<Double> minMaxWaveform);
MinMaxWaveform<Int32> Channels[].Measurement.FetchWaveformMinMax (
    MinMaxWaveform<Int32> minMaxWaveform);
MinMaxWaveform<Int16> Channels[].Measurement.FetchWaveformMinMax (
    MinMaxWaveform<Int16> minMaxWaveform);
MinMaxWaveform<Byte> Channels[].Measurement.FetchWaveformMinMax (
    MinMaxWaveform<Byte> minMaxWaveform);
```

COM Method Prototype

```
HRESULT Measurements.Item().FetchWaveformMinMax (
    [in,out] SAFEARRAY(DOUBLE) *MinWaveform,
    [in,out] SAFEARRAY(DOUBLE) *MaxWaveform,
    [in,out] DOUBLE *InitialX,
    [in,out] DOUBLE *XIncrement);
```

C Prototype

```
ViStatus IviScope_FetchMinMaxWaveform (ViSession Vi,
    ViConstString Channel,
    ViInt32 WaveformSize,
    ViReal64 MinWaveform[],
    ViReal64 MaxWaveform[],
    ViInt32 *ActualPoints,
    ViReal64 *InitialX,
    ViReal64 *XIncrement);
```

Parameters

Inputs	Description	Base Type
Vi	Instrument handle	ViSession
Channel	Name of the channel from which to read a waveform.	ViConstString
WaveformSize	Specifies the number of elements in the MinWaveform and MaxWaveform arrays.	ViInt32
MinMaxWaveform	MinMaxWaveform object with data of a particular size needed only for reusing waveform object across reads.	MinMaxWaveform<T>

Outputs	Description	Base Type
---------	-------------	-----------

MinWaveform (C/COM)	A user-allocated buffer into which the min waveform is stored.	ViReal64[]
MaxWaveform (C/COM)	A user-allocated buffer into which the max waveform is stored.	ViReal64[]
ActualPoints	Number of points actually acquired in each waveform	ViInt32
InitialX	The time in relation to the Trigger Event of the first point in the waveform in seconds.	ViReal64
XIncrement	The time between points in the acquired waveform in seconds.	ViReal64
Return Value (.NET)	MinMaxWaveform object with data from the channel. (In .NET, this is the return value of the method.) (The IVI-3.18: <i>IVI.NET Utility Classes and Interfaces Specification</i> defines the IWaveform interface.)	MinMaxWaveform<T>

Return Values (C/COM)

The *IVI-3.2: Inherent Capabilities Specification* defines general status codes that this function can return. The table below specifies additional class-defined status codes for this function.

Completion Codes	Description
Invalid Waveform Element	Warning: One of the elements in the waveform array is invalid.
Channel Not Enabled	Error: Specified channel is not enabled for acquisition.
Invalid Acquisition Type	Error: Invalid acquisition type.

.NET Exceptions

The *IVI-3.2: Inherent Capabilities Specification* defines general exceptions that may be thrown, and warning events that may be raised, by this method. The *IVI-3-18: IVI.NET Utility Classes and Interfaces Specification* defines additional waveform-related exceptions that may be thrown by this method.

The table below specifies additional class-defined exceptions for this method.

Exception Class	Description
InvalidAquisitionTypeException	Invalid acquisition type
ChannelNotEnabledException	Specified channel is not enabled for acquisition.

The table below specifies additional class-defined warning events for this method.

Warning	Description
Invalid Waveform Element	One of the elements in the waveform array is invalid.

12.3.3.Read Min Max Waveform

Description

This function initiates new waveform acquisition and returns minimum and maximum waveforms from a specific channel. If the channel is not enabled for the acquisition, this function returns the Channel Not Enabled error.

This function is used when the Acquisition Type is Peak Detect or Envelope . If the acquisition type is not one of the listed types, the function returns the Invalid Acquisition Type error.

This function initiates an acquisition on the enabled channels. It then waits for the acquisition to complete, and returns the min/max waveforms for the specified channel. Call the Fetch Min Max Waveform function to obtain the min/max waveforms for each of the remaining enabled channels without initiating another acquisition. If the oscilloscope did not complete the acquisition within the time period the user specified with the `MaxTimeMilliseconds` parameter, the function returns the Max Time Exceeded error.

The behavior is different for IVI-C/IVI-Com and IVI.NET as follows:

IVI-C/IVI-COM: After this function executes, each element in the `waveformArray` parameter is either a voltage or a value indicating that the oscilloscope could not sample a voltage.

IVI.NET: For .NET the return value of `IWaveform<T>` is a waveform object. Refer to Section 4, *Common Properties and Methods of Waveform and Spectrum Interfaces*, and Section 5, *IWaveform<T> Interface*, of *IVI-3.2: Inherent Capabilities Specification*, for the definition of the `IWaveform` object and information regarding its use. In particular, refer to Section 4.2, *How to use Waveform and Spectrum Types*, in *IVI-3.18: IVI.NET Utility Classes and Interfaces Specification*, for more information about how to implement these methods.

For all uses of `WaveformMinMax<T>`, the `InitialX`, `XIncrement`, and array sizes must match for both min and max waveforms.

The C end-user configures the interpolation method the oscilloscope uses with the `IviScope_ConfigureInterpolation` function. The COM end-user uses the `Acquisition.Interpolation` property. If interpolation is disabled, the oscilloscope does not interpolate points in the waveform. If the oscilloscope cannot sample a value for a point in the waveform, the driver sets the corresponding element in the `MinWaveform` or `MaxWaveform` to an IEEE-defined NaN (Not a Number) value and the function returns the Invalid Waveform Element warning. For C and COM, the function returns the Invalid Waveform Element warning. For .NET, the `IWaveform` return value includes a property that indicates if there is an invalid waveform element.

For C and COM, use the `Is Waveform Element Invalid` function to test each element in the `waveformArray` parameter for an invalid waveform element. For .NET, check for `Double.IsNaN` if the waveform is of type `Double`.

.NET MinMax Waveform Struct

```
Struct MinMaxWaveform<T>
{
    Public MinMaxWaveform(IWaveform<T> minWaveform, IWaveform<T> maxWaveform);
    public IWaveform<T> MinWaveform { get; }
    public IWaveform<T> MaxWaveform { get; }
}
```

.NET Method Prototype

```
MinMaxWaveform<Double> Channels[].Measurement.ReadWaveformMinMax (
    PrecisionTimeSpan maximumTime,
```



```

        MinMaxWaveform<Double> minMaxWaveform);
MinMaxWaveform<Int32> Channels[].Measurement.ReadWaveformMinMax (
    PrecisionTimeSpan maximumTime,
    MinMaxWaveform<Int32> minMaxWaveform);
MinMaxWaveform<Int16> Channels[].Measurement.ReadWaveformMinMax (
    PrecisionTimeSpan maximumTime,
    MinMaxWaveform<Int16> minMaxWaveform);
MinMaxWaveform<Byte> Channels[].Measurement.ReadWaveformMinMax (
    PrecisionTimeSpan maximumTime,
    MinMaxWaveform<Byte> minMaxWaveform);

```

COM Method Prototype

```

HRESULT Measurements.Item().ReadWaveformMinMax (
    [in] LONG MaxTimeMilliseconds,
    [in,out] SAFEARRAY(DOUBLE) *MinWaveform,
    [in,out] SAFEARRAY(DOUBLE) *MaxWaveform,
    [in,out] DOUBLE *InitialX,
    [in,out] DOUBLE *XIncrement);

```

C Prototype

```

ViStatus IviScope_ReadMinMaxWaveform (ViSession Vi,
    ViConstString Channel,
    ViInt32 WaveformSize,
    ViInt32 MaxTimeMilliseconds,
    ViReal64 MinWaveform[],
    ViReal64 MaxWaveform[],
    ViInt32 *ActualPoints,
    ViReal64 *InitialX,
    ViReal64 *XIncrement);

```

Parameters

Inputs	Description	Base Type
Vi	Instrument handle	ViSession
Channel	Name of the channel from which to read a waveform.	ViConstString
WaveformSize	Specifies the number of elements in the <code>minWaveform</code> and <code>maxWaveform</code> arrays.	ViInt32
MaxTime Milliseconds (C/COM)	Specifies the maximum time allowed for this function to complete in milliseconds. Defined values: Max Time Immediate - The function returns immediately. If no valid measurement value exists, the function returns an error. Max Time Infinite - The function waits indefinitely for the measurement to complete.	ViInt32
maximumTime (.NET)	Specifies the maximum time allowed for this function to complete. The units are implicit in the definition of <code>TimeSpan</code>	<code>TimeSpan</code>
MinMaxWaveform	MinMaxWaveform object with data of a particular size needed only for reusing waveform object across reads.	MinMaxWaveform<T>

Outputs	Description	Base Type
MinWaveform (C/COM)	A user-allocated buffer into which the min waveform is stored.	ViReal64[]
MaxWaveform (C/COM)	A user-allocated buffer into which the max waveform is stored.	ViReal64[]
ActualPoints	Number of points actually acquired in each waveform.	ViInt32
InitialX	The time in relation to the Trigger Event of the first point in the waveform in seconds.	ViReal64
XIncrement	The time between points in the acquired waveform in seconds.	ViReal64
Return Value (.NET)	MinMaxWaveform object with data from the channel. (In .NET, this is the return value of the method.) (The IVI-3.2: Inherent Capabilities Specification defines the IWaveform object.)	MinMaxWaveform<T>

Defined Values for the MaxTimeMilliseconds Parameter (IVI-C & IVI-COM Only)

<i>Name</i>	<i>Description</i>	
	<i>Language</i>	<i>Identifier</i>
Max Time Immediate	The function returns immediately. If no valid measurement value exists, the function returns an error.	
	C	IVISCOPE_VAL_MAX_TIME_IMMEDIATE
	COM	IviScopeTimeOutImmediate
Max Time Infinite	The function waits indefinitely for the measurement to complete.	
	C	IVISCOPE_VAL_MAX_TIME_INFINITE
	COM	IviScopeTimeOutInfinite

Defined Values for the maximumTime Parameter (IVI.NET Only)

<i>Name</i>	<i>Description</i>	
	<i>Language</i>	<i>Identifier</i>
Zero	The function returns immediately. If no valid measurement value exists, the function returns an error.	
	.NET	TimeSpan.Zero
Max Value	The function waits indefinitely for the measurement to complete.	
	.NET	TimeSpan.MaxValue

Return Values (C/COM)

The *IVI-3.2: Inherent Capabilities Specification* defines general status codes that this function can return. The table below specifies additional class-defined status codes for this function.

Completion Codes	Description
Invalid Waveform Element	Warning: One of the elements in the waveform array is invalid.
Channel Not Enabled	Error: Specified channel is not enabled for acquisition.
Invalid Acquisition Type	Error: Invalid acquisition type.
Max Time Exceeded	Error: Maximum time exceeded before the operation completed.

.NET Exceptions

The *IVI-3.2: Inherent Capabilities Specification* defines general exceptions that may be thrown, and warning events that may be raised, by this method. The *IVI-3-18: IVI.NET Utility Classes and Interfaces Specification* defines additional waveform-related exceptions that may be thrown by this method.

The table below specifies additional class-defined exceptions for this method.

Exception Class	Description
InvalidAquisitionTypeException	Invalid acquisition type
ChannelNotEnabledException	Specified channel is not enabled for acquisition.

The table below specifies additional class-defined warning events for this method.

Warning	Description
Invalid Waveform Element	One of the elements in the waveform array is invalid.

Note that the .NET `MaxTimeExceededException` is defined in *IVI-3.2: Inherent Capabilities Specification*.

Compliance Notes

The specific instrument driver is not required to support any of the defined values for the `MaxTimeMilliseconds` or `maximumTime` parameters.

12.4. IviScopeMinMaxWaveform Behavior Model

The IviScopeMinMaxWaveform group uses the behavior model defined by the IviScopeBase Capabilities.

12.5. IviScopeMinMaxWaveform Compliance Notes

1. IVI Class-Compliant specific drivers that implement this extension group shall implement at least one of the following values for the Acquisition Type attribute in the IviScopeBase capabilities group:
 - Peak Detect
 - Envelope
2. An IVI Class-Compliant specific driver does not have to implement the Number of Envelopes attribute if it does not implement the Envelope value for the Acquisition Type attribute. In addition, an IVI-C specific driver does not have to implement the Configure Number of Envelopes function if it does not implement the Envelope value for the Acquisition Type attribute.

13.IviScopeProbeAutoSense Extension Group

13.1.IviScopeProbeAutoSense Overview

The IviScopeProbeAutoSense extension group provides support for oscilloscopes that can return the probe attenuation of the attached probe.

13.2.IviScopeProbeAutoSense Attributes

The IviScopeProbeAutoSense capability group defines the following attribute:

- Probe Attenuation Auto (IVI.NET Only)
- Probe Sense Value (IVI-C & IVI-COM Only)

This section describes the behavior and requirements of this attribute. The actual value for this attribute ID is defined in Section 19, *IviScope Attribute ID Definitions*.

13.2.1. Probe Attenuation Auto (IVI.NET Only)

Data Type	Access	Applies to	Coercion	High Level Functions
ViBoolean	R/W	Channel	None	Configure Channel

.NET Property Name

`Channels[].ProbeAttenuationAuto`

COM Property Name

N/A
(See the Probe Attenuation attribute.)

C Constant Name

N/A
(See the Probe Attenuation attribute.)

Description

If this attribute is True, the driver configures the oscilloscope to sense the attenuation of the probe automatically

If this attribute is False, the driver disables the automatic probe sense and configures the oscilloscope to use the value of the Probe Attenuation attribute.

The actual probe attenuation the DMM is currently using can be determined from the Probe Attenuation attribute.

Setting the Probe Attenuation attribute also sets the Probe Attenuation Auto attribute to false.

Note that IVI-COM and IVI-C achieve this behavior by setting Probe Attenuation to the Probe Sense On value, which is defined as -1.

.NET Exceptions

The *IVI-3.2: Inherent Capabilities Specification* defines general exceptions that may be thrown, and warning events that may be raised, by this method.

13.2.2. Probe Sense Value (IVI-C & IVI-COM Only)

Data Type	Access	Applies to	Coercion	High Level Functions
ViReal64	RO	Channel	None	Auto Probe Sense Value (IVI-C only)

.NET Property Name

N/A

See the Probe Attenuation attribute.

COM Property Name

`Channels.Item().ProbeSense`

C Constant Name

`IVISCOPE_ATTR_PROBE_SENSE_VALUE`

Description

Returns the probe attenuation value that the oscilloscope automatically senses. This value is the scaling factor by which the probe the end-user attaches to the channel attenuates the input. If the auto probe sense capability is not enabled, this attribute returns the current manual probe attenuation setting.

13.3. IviScopeProbeAutoSense Functions

The IviScopeProbeAutoSense capability group defines the following function:

- Auto Probe Sense Value (IVI-C only)

This section describes the behavior and requirements of this function.

13.3.1.Auto Probe Sense Value (IVI-C only)

Description

The function returns the probe attenuation value the oscilloscope senses. The capability is enabled by setting the `probeAttenuation` parameter of the `Configure Channel` function to `Probe Sense On`.

If the automatic probe sense capability is disabled, this function returns the manual probe attenuation setting.

.NET Method Prototype

N/A
(use the `Channels[] . ProbeSense` property)

COM Method Prototype

N/A
(use the `Channels.Item() . ProbeSense` property)

C Prototype

```
ViStatus IviScope_AutoProbeSenseValue (ViSession Vi,  
                                       ViConstString Channel,  
                                       ViReal64 *AutoProbeSenseValue);
```

Parameters

Inputs	Description	Base Type
Vi	Instrument handle	ViSession

Outputs	Description	Base Type
AutoProbeSense Value	Returns the probe attenuation value the oscilloscope senses. The driver returns the value of the Probe Sense Value attribute. See the Probe Sense Value attribute for a complete description.	ViReal64

Return Values (C)

The *IVI-3.2: Inherent Capabilities Specification* defines general status codes that this function can return.

13.4. IviScopeProbeAutoSense Behavior Model

The IviScopeProbeAutoSense group uses the behavior model defined by the IviScopeBase Capabilities.

13.5. IviScopeProbeAutoSense Compliance Notes

IVI Class-Compliant specific drivers that implement this extension group shall implement the Probe Sense On value for the Probe Attenuation attribute in the IviScopeBase capabilities group.

14.IviScopeContinuousAcquisition Extension Group

14.1.IviScopeContinuousAcquisition Overview

The IviScopeContinuousAcquisition extension group provides support for oscilloscopes that can perform a continuous acquisition.

14.2.IviScopeContinuousAcquisition Attributes

The IviScopeContinuousAcquisition capability group defines the following attribute:

- Initiate Continuous

This section describes the behavior and requirements of this attribute. The actual value for this attribute ID is defined in Section 19, *IviScope Attribute ID Definitions*.

14.2.1. Initiate Continuous

Data Type	Access	Applies to	Coercion	High Level Functions
ViBoolean	R/W	N/A	None	Configure Initiate Continuous (IVI-C only)

.NET Property Name

`Trigger.Continuous`

COM Property Name

`Trigger.Continuous`

C Constant Name

`IVISCOPE_ATTR_INITIATE_CONTINUOUS`

Description

Specifies whether the oscilloscope continuously initiates waveform acquisition. If the end-user sets this attribute to True, the oscilloscope immediately waits for another trigger after the previous waveform acquisition is complete. Setting this attribute to True is useful when the end-user requires continuous updates of the oscilloscope display. This specification does not define the behavior of the read waveform and fetch waveform functions when this attribute is set to True. The behavior of these functions is instrument specific.

.NET Exceptions

The *IVI-3.2: Inherent Capabilities Specification* defines general exceptions that may be thrown, and warning events that may be raised, by this property.

Compliance Notes

The IVI Class-Compliant specific driver shall implement both the True and False values.

14.3. IviScopeContinuousAcquisition Functions

The IviScopeContinuousAcquisition capability group defines the following function:

- Configure Initiate Continuous (IVI-C only)

This section describes the behavior and requirements of this function.

14.3.1. Configure Initiate Continuous (IVI-C only)

Description

This function configures the oscilloscope to perform a continuous acquisition.

.NET Method Prototype

N/A
(use the `Trigger.Continuous` property)

COM Method Prototype

N/A
(use the `Trigger.Continuous` property)

C Prototype

```
ViStatus IviScope_ConfigureInitiateContinuous (ViSession Vi,  
                                              ViBoolean ContinuousAcquisition);
```

Parameters

Inputs	Description	Base Type
Vi	Instrument handle	ViSession
Continuous Acquisition	Specifies if the oscilloscope is enabled for continuous acquisition. The driver uses this value to set the Initiate Continuous attribute. See the attribute description for more information	ViBoolean

Return Values (C)

The *IVI-3.2: Inherent Capabilities Specification* defines general status codes that this function can return.

14.4. IviScopeContinuousAcquisition Behavior Model

The following behavior diagram shows relationships between IviScopeContinuousAcquisition Capabilities and oscilloscope behavior.

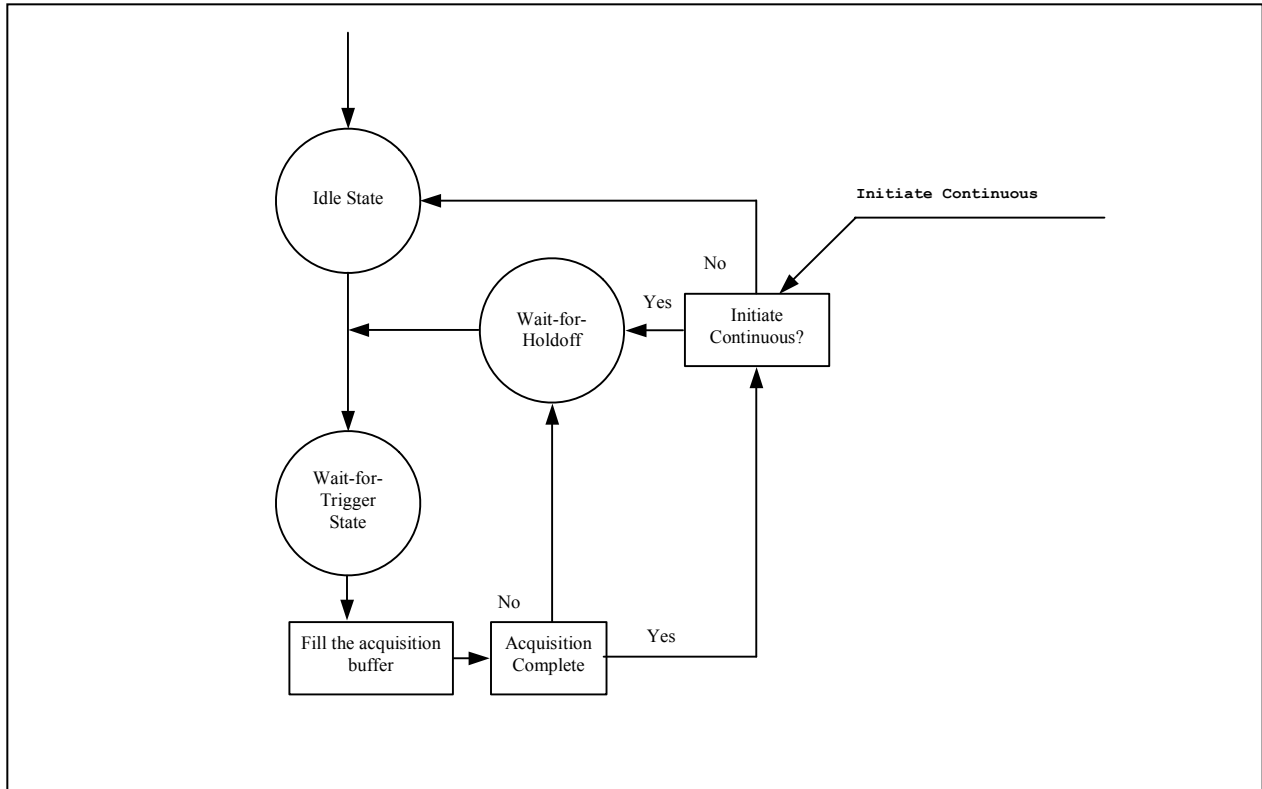

Figure 14-1. IviScopeContinuousAcquisition Behavior Model

The IviScopeContinuousAcquisition extension group adds the attribute that controls whether the instrument operates in a single-shot mode or if it acquires the data continuously.

After the oscilloscope completes an acquisition, if the Initiate Continuous attribute is set to True, the instrument goes to the *Wait-for-Trigger* state instead of returning to the *Idle* state. Setting this attribute to True is useful when the end-user requires continuous updates of the oscilloscope display. This specification does not define the behavior of the read and fetch functions when this attribute is set to True. The behavior of these functions is instrument specific.

15.IviScopeAverageAcquisition Extension Group

15.1.IviScopeAverageAcquisition Overview

The IviScopeAverageAcquisition extension group provides support for oscilloscopes that can perform the average acquisition.

15.2.IviScopeAverageAcquisition Attributes

The IviScopeAverageAcquisition capability group defines the following attribute:

- Number of Averages

This section describes the behavior and requirements of this attribute. The actual value for this attribute ID is defined in Section 19, *IviScope Attribute ID Definitions*.

15.2.1. Number of Averages

Data Type	Access	Applies to	Coercion	High Level Functions
ViInt32	R/W	N/A	None	Configure Number of Averages (IVI-C only)

.NET Property Name

Acquisition.NumberOfAverages

COM Property Name

Acquisition.NumberOfAverages

C Constant Name

IVISCOPE_ATTR_NUM_AVERAGES

Description

Specifies the number of waveform the oscilloscope acquires and averages. After the oscilloscope acquires as many waveforms as this attribute specifies, it returns to the idle state. This attribute affects instrument behavior only when the Acquisition Type attribute is set to Average.

.NET Exceptions

The *IVI-3.2: Inherent Capabilities Specification* defines general exceptions that may be thrown, and warning events that may be raised, by this property.

15.3. IviScopeAverageAcquisition Functions

The IviScopeAverageAcquisition capability group defines the following function:

- Configure Number of Averages (IVI-C only)

This section describes the behavior and requirements of this function.

15.3.1. Configure Number of Averages (IVI-C only)

Description

This function configures the number of waveforms that the oscilloscope acquires and averages. After the oscilloscope acquires number of waveforms specified, it returns to the idle state.

Set the acquisition type to Average before calling this function. If the acquisition type is not set to Average, the function returns the Invalid Acquisition Type error.

.NET Method Prototype

N/A
(use the `Acquisition.NumberOfAverages` property)

COM Method Prototype

N/A
(use the `Acquisition.NumberOfAverages` property)

C Prototype

```
ViStatus IviScope_ConfigureNumAverages (ViSession Vi,  
                                         ViInt32 NumberOfAverages);
```

Parameters

Inputs	Description	Base Type
Vi	Instrument handle	ViSession
NumberOfAverages	Specifies the number of waveforms the oscilloscope acquires and averages. The driver sets the Number of Averages attribute to this value.	ViInt32

Return Values (C)

The *IVI-3.2: Inherent Capabilities Specification* defines general status codes that this function can return. The table below specifies additional class-defined status codes for this function.

Completion Codes	Description
Invalid Acquisition Type	Error: Invalid acquisition type.

15.4. IviScopeAverageAcquisition Behavior Model

The IviScopeAverageAcquisition group uses the behavior model defined by the IviScopeBase Capabilities.

15.5. IviScopeAverageAcquisition Compliance Notes

IVI Class-Compliant specific drivers that implement this extension group shall implement the Average value for the Acquisition Type attribute in the IviScopeBase capabilities group.

16.IviScopeSampleMode Extension Group

16.1.IviScopeSampleMode Overview

The IviScopeSampleMode extension group provides support for oscilloscopes that can return whether they are using equivalent time or real time sampling to acquire waveform.

16.2.IviScopeSampleMode Attributes

The IviScopeSampleMode capability group defines the following attribute:

- Sample Mode

This section describes the behavior and requirements of this attribute. The actual value for this attribute ID is defined in Section 19, *IviScope Attribute ID Definitions*.

16.2.1. Sample Mode

Data Type	Access	Applies to	Coercion	High Level Functions
ViInt32	RO	N/A	None	SampleMode

.NET Property Name

`Acquisition.SampleMode`

.NET Enumeration Name

`SampleMode`

COM Property Name

`Acquisition.SampleMode`

COM Enumeration Name

`IviScopeSampleModeEnum`

C Constant Name

`IVISCOPE_ATTR_SAMPLE_MODE`

Description

Returns the sample mode the oscilloscope is currently using.

Defined Values

<i>Name</i>	<i>Description</i>	
	<i>Language</i>	<i>Identifier</i>
Real Time	Indicates that the oscilloscope is using real-time sampling.	
	.NET	<code>SampleMode.RealTime</code>
	C	<code>IVISCOPE_VAL_REAL_TIME</code>
COM	<code>IviScopeSampleModeRealTime</code>	
Equivalent Time	Indicates that the oscilloscope is using equivalent time sampling.	
	.NET	<code>SampleMode.EquivalentTime</code>
	C	<code>IVISCOPE_VAL_EQUIVALENT_TIME</code>
COM	<code>IviScopeSampleModeEquivalentTime</code>	

.NET Exceptions

The *IVI-3.2: Inherent Capabilities Specification* defines general exceptions that may be thrown, and warning events that may be raised, by this method.

16.3. IviScopeSampleMode Functions

The IviScopeSampleMode capability group defines the following function:

- Sample Mode (IVI-C only)

This section describes the behavior and requirements of this function.

16.3.1. Sample Mode (IVI-C only)

Description

This function returns the sample mode the oscilloscope is currently using.

.NET Method Prototype

N/A
(use the `Acquisition.SampleMode` property)

COM Method Prototype

N/A
(use the `Acquisition.SampleMode` property)

C Prototype

```
ViStatus IviScope_SampleMode (ViSession Vi,  
                              ViInt32 *SampleMode);
```

Parameters

Inputs	Description	Base Type
Vi	Instrument handle	ViSession

Outputs	Description	Base Type
SampleMode	Returns the sample mode the oscilloscope is currently using. The driver returns the value of the Sample Mode attribute. See the Sample Mode attribute for a complete description and defined values.	ViInt32

Return Values (C)

The *IVI-3.2: Inherent Capabilities Specification* defines general status codes that this function can return.

16.4. IviScopeSampleMode Behavior Model

The IviScopeSampleMode group uses the behavior model defined by the IviScopeBase Capabilities.

17. IviScopeTriggerModifier Extension Group

17.1. IviScopeTriggerModifier Overview

The IviScopeTriggerModifier extension group provides support for oscilloscopes that can specify the behavior of the triggering subsystem in the absence of the configured trigger.

17.2. IviScopeTriggerModifier Attributes

The IviScopeTriggerModifier capability group defines the following attribute:

- Trigger Modifier

This section describes the behavior and requirements of this attribute. The actual value for this attribute ID is defined in Section 19, *IviScope Attribute ID Definitions*.

17.2.1. Trigger Modifier

Data Type	Access	Applies to	Coercion	High Level Functions
ViInt32	R/W	N/A	None	IviScope_ConfigureTriggerModifier

.NET Property Name

`Trigger.Modifier`

.NET Enumeration Name

`TriggerModifier`

COM Property Name

`Trigger.Modifier`

COM Enumeration Name

`IviScopeTriggerModifierEnum`

C Constant Name

`IVISCOPE_ATTR_TRIGGER_MODIFIER`

Description

Specifies the trigger modifier. The trigger modifier determines the oscilloscope's behavior in the absence of the configured trigger.

Defined Values

<i>Name</i>	<i>Description</i>	
	<i>Language</i>	<i>Identifier</i>
No Trigger Modifier	The oscilloscope waits until the trigger the end-user specifies occurs.	
	.NET	TriggerModifier.None
	C	IVISCOPE_VAL_NO_TRIGGER_MOD
	COM	IviScopeTriggerModifierNone
Auto	The oscilloscope automatically triggers if the configured trigger does not occur within the oscilloscope's timeout period.	
	.NET	TriggerModifier.Auto
	C	IVISCOPE_VAL_AUTO
	COM	IviScopeTriggerModifierAuto
Auto Level	The oscilloscope adjusts the trigger level if the trigger the end-user specifies does not occur.	
	.NET	TriggerModifier.AutoLevel
	C	IVISCOPE_VAL_AUTO_LEVEL
	COM	IviScopeTriggerModifierAutoLevel

.NET Exceptions

The *IVI-3.2: Inherent Capabilities Specification* defines general exceptions that may be thrown, and warning events that may be raised, by this method.

Compliance Notes

- Instrument driver shall support the value No Trigger Modifier and at least one of the following values:
 - Auto
 - Auto Level
- If an IVI-C class driver defines additional values for this attribute, the actual values shall be greater than or equal to `IVISCOPE_VAL_TRIGGER_MOD_CLASS_EXT_BASE` and less than `IVISCOPE_VAL_TRIGGER_MOD_SPECIFIC_EXT_BASE`.
- If an IVI-C specific driver defines additional values for this attribute, the actual values shall be greater than or equal to `IVISCOPE_VAL_TRIGGER_MOD_SPECIFIC_EXT_BASE`.

17.3. IviScopeTriggerModifier Functions

The IviScopeTriggerModifier capability group defines the following function:

- Configure Trigger Modifier (IVI-C only)

This section describes the behavior and requirements of this function.

17.3.1. Configure Trigger Modifier (IVI-C only)

Description

This function configures the oscilloscope's trigger modifier.

.NET Method Prototype

N/A
(use the `Trigger.Modifier` property)

COM Method Prototype

N/A
(use the `Trigger.Modifier` property)

C Prototype

```
ViStatus IviScope_ConfigureTriggerModifier (ViSession Vi,  
                                             ViInt32 TriggerModifier);
```

Parameters

Inputs	Description	Base Type
Vi	Instrument handle	ViSession
TriggerModifier	Specifies the method the oscilloscope uses in the absence of trigger conditions. The driver sets the Trigger Modifier attribute to this value. See the attribute description for more information and defined values.	ViInt32

Return Values (C)

The *IVI-3.2: Inherent Capabilities Specification* defines general status codes that this function can return.

17.4. IviScopeTriggerModifier Behavior Model

The IviScopeTriggerModifier group uses the behavior model defined by the IviScopeBase Capabilities.

18.IviScopeAutoSetup Extension Group

18.1.IviScopeAutoSetup Overview

The IviScopeAutoSetup extension group provides support for oscilloscopes that can perform an auto-setup operation.

18.2.IviScopeAutoSetup Functions

The IviScopeAutoSetup capability group defines the following function:

- Auto Setup

This section describes the behavior and requirements of this function.

18.2.1.Auto Setup

Description

This function performs an auto-setup on the instrument.

.NET Method Prototype

```
void Measurement.AutoSetup()
```

COM Method Prototype

```
HRESULT Measurements.AutoSetup()
```

C Prototype

```
ViStatus IviScope_AutoSetup (ViSession Vi);
```

Parameters

Inputs	Description	Base Type
Vi	Instrument handle	ViSession

Return Values

The *IVI-3.2: Inherent Capabilities Specification* defines general status codes that this function can return.

.NET Exceptions

The *IVI-3.2: Inherent Capabilities Specification* defines general exceptions that may be thrown, and warning events that may be raised, by this method.

18.3. IviScopeAutoSetup Behavior Model

The IviScopeAutoSetup group uses the behavior model defined by the IviScopeBase Capabilities.

19.IviScope Attribute ID Definitions

The following table defines the ID value for all IviScope class attributes.

Table 191. IviScope Attribute ID Values

Attribute Name	ID Value
IVISCOPE_ATTR_VERTICAL_RANGE	IVI_CLASS_ATTR_BASE + 1
IVISCOPE_ATTR_VERTICAL_OFFSET	IVI_CLASS_ATTR_BASE + 2
IVISCOPE_ATTR_VERTICAL_COUPLING	IVI_CLASS_ATTR_BASE + 3
IVISCOPE_ATTR_PROBE_ATTENUATION	IVI_CLASS_ATTR_BASE + 4
IVISCOPE_ATTR_CHANNEL_ENABLED	IVI_CLASS_ATTR_BASE + 5
IVISCOPE_ATTR_MAX_INPUT_FREQUENCY	IVI_CLASS_ATTR_BASE + 6
IVISCOPE_ATTR_HORZ_TIME_PER_RECORD	IVI_CLASS_ATTR_BASE + 7
IVISCOPE_ATTR_HORZ_RECORD_LENGTH	IVI_CLASS_ATTR_BASE + 8
IVISCOPE_ATTR_HORZ_MIN_NUM_PTS	IVI_CLASS_ATTR_BASE + 9
IVISCOPE_ATTR_HORZ_SAMPLE_RATE	IVI_CLASS_ATTR_BASE + 10
IVISCOPE_ATTR_TRIGGER_TYPE	IVI_CLASS_ATTR_BASE + 12
IVISCOPE_ATTR_TRIGGER_SOURCE	IVI_CLASS_ATTR_BASE + 13
IVISCOPE_ATTR_TRIGGER_COUPLING	IVI_CLASS_ATTR_BASE + 14
IVISCOPE_ATTR_TRIGGER_HOLDOFF	IVI_CLASS_ATTR_BASE + 16
IVISCOPE_ATTR_TRIGGER_LEVEL	IVI_CLASS_ATTR_BASE + 17
IVISCOPE_ATTR_TRIGGER_SLOPE	IVI_CLASS_ATTR_BASE + 18
IVISCOPE_ATTR_INTERPOLATION	IVI_CLASS_ATTR_BASE + 19
IVISCOPE_ATTR_ACQUISITION_TYPE	IVI_CLASS_ATTR_BASE + 101
IVISCOPE_ATTR_TRIGGER_MODIFIER	IVI_CLASS_ATTR_BASE + 102
IVISCOPE_ATTR_INPUT_IMPEDANCE	IVI_CLASS_ATTR_BASE + 103
IVISCOPE_ATTR_NUM_AVERAGES	IVI_CLASS_ATTR_BASE + 104
IVISCOPE_ATTR_NUM_ENVELOPES	IVI_CLASS_ATTR_BASE + 105
IVISCOPE_ATTR_SAMPLE_MODE	IVI_CLASS_ATTR_BASE + 106
IVISCOPE_ATTR_INITIATE_CONTINUOUS	IVI_CLASS_ATTR_BASE + 107
IVISCOPE_ATTR_PROBE_SENSE_VALUE	IVI_CLASS_ATTR_BASE + 108
IVISCOPE_ATTR_ACQUISITION_START_TIME	IVI_CLASS_ATTR_BASE + 109
IVISCOPE_ATTR_TV_TRIGGER_SIGNAL_FORMAT	IVI_CLASS_ATTR_BASE + 201
IVISCOPE_ATTR_TV_TRIGGER_POLARITY	IVI_CLASS_ATTR_BASE + 204
IVISCOPE_ATTR_TV_TRIGGER_EVENT	IVI_CLASS_ATTR_BASE + 205
IVISCOPE_ATTR_TV_TRIGGER_LINE_NUMBER	IVI_CLASS_ATTR_BASE + 206
IVISCOPE_ATTR_RUNT_HIGH_THRESHOLD	IVI_CLASS_ATTR_BASE + 301
IVISCOPE_ATTR_RUNT_LOW_THRESHOLD	IVI_CLASS_ATTR_BASE + 302

Table 191. IviScope Attribute ID Values

Attribute Name	ID Value
IVISCOPE_ATTR_RUNT_POLARITY	IVI_CLASS_ATTR_BASE + 303
IVISCOPE_ATTR_GLITCH_WIDTH	IVI_CLASS_ATTR_BASE + 401
IVISCOPE_ATTR_GLITCH_POLARITY	IVI_CLASS_ATTR_BASE + 402
IVISCOPE_ATTR_GLITCH_CONDITION	IVI_CLASS_ATTR_BASE + 403
IVISCOPE_ATTR_WIDTH_LOW_THRESHOLD	IVI_CLASS_ATTR_BASE + 501
IVISCOPE_ATTR_WIDTH_HIGH_THRESHOLD	IVI_CLASS_ATTR_BASE + 502
IVISCOPE_ATTR_WIDTH_POLARITY	IVI_CLASS_ATTR_BASE + 503
IVISCOPE_ATTR_WIDTH_CONDITION	IVI_CLASS_ATTR_BASE + 504
IVISCOPE_ATTR_MEAS_HIGH_REF	IVI_CLASS_ATTR_BASE + 607
IVISCOPE_ATTR_MEAS_LOW_REF	IVI_CLASS_ATTR_BASE + 608
IVISCOPE_ATTR_MEAS_MID_REF	IVI_CLASS_ATTR_BASE + 609
IVISCOPE_ATTR_AC_LINE_TRIGGER_SLOPE	IVI_CLASS_ATTR_BASE + 701
IVISCOPE_ATTR_CHANNEL_COUNT	IVI_INHERENT_ATTR_BASE + 203
IVISCOPE_ATTR_MEASUREMENT_CHANNEL_COUNT	IVI_CLASS_ATTR_BASE + 802

19.1. IviScope Obsolete Attribute Names

The following attribute names are reserved by the IviScope specification 1.0. Future versions of this specification cannot use these names:

IVISCOPE_ATTR_BANDWIDTH
 IVISCOPE_ATTR_HORZ_RECORD_REF_POSITION
 IVISCOPE_ATTR_TRIGGER_DELAY_TIME
 IVISCOPE_ATTR_TV_TRIGGER_SIGNAL_TYPE
 IVISCOPE_ATTR_TV_TRIGGER_FIELD
 IVISCOPE_ATTR_TV_TRIGGER_LINE

19.2. IviScope Obsolete Attribute ID Values

The following attribute IDs are reserved by the IviScope specification 1.0. Future versions of this specification cannot use these values:

1250011 (IVI_CLASS_ATTR_BASE + 11)
 1250015 (IVI_CLASS_ATTR_BASE + 15)
 1250202 (IVI_CLASS_ATTR_BASE + 202)
 1250203 (IVI_CLASS_ATTR_BASE + 203)

20.IviScope Attribute Value Definitions

This section specifies the actual value for each defined attribute value.

Acquisition Type

Value Name	Language	Identifier	Actual Value
Normal	.NET	AcquisitionType.Normal	0
	C	IVISCOPE_VAL_NORMAL	0
	COM	IviScopeAcquisitionTypeNormal	0
Peak Detect	.NET	AcquisitionType.PeakDetect	1
	C	IVISCOPE_VAL_PEAK_DETECT	1
	COM	IviScopeAcquisitionTypePeakDetect	1
High Resolution	.NET	AcquisitionType.HiResolution	2
	C	IVISCOPE_VAL_HI_RES	2
	COM	IviScopeAcquisitionTypeHiRes	2
Envelope	.NET	AcquisitionType.Envelope	3
	C	IVISCOPE_VAL_ENVELOPE	3
	COM	IviScopeAcquisitionTypeEnvelope	3
Average	.NET	AcquisitionType.Average	4
	C	IVISCOPE_VAL_AVERAGE	4
	COM	IviScopeAcquisitionTypeAverage	4
Acquisition Type Class Ext Base	C	IVISCOPE_VAL_ACQUISITION_TYPE_CLASS_EXT_BASE	100
Acquisition Type Specific Ext Base	C	IVISCOPE_VAL_ACQUISITION_TYPE_SPECIFIC_EXT_BASE	1000
	COM	N/A	

Probe Attenuation (IVI-C & IVI-COM Only)

Value Name	Language	Identifier	Actual Value
Probe Sense On	C	IVISCOPE_VAL_PROBE_SENSE_ON	-1
	COM	-1	-1
Probe Attenuation Class Ext Base	C	IVISCOPE_VAL_PROBE_ATTENUATION_CLASS_EXT_BASE	-100
Probe Attenuation Specific Ext Base	C	IVISCOPE_VAL_PROBE_ATTENUATION_SPECIFIC_EXT_BASE	-1000
	COM	N/A	

Vertical Coupling

Value Name	Language	Identifier	Actual Value
AC	.NET	VerticalCoupling.AC	0
	C	IVISCOPE_VAL_AC	0
	COM	IviScopeVerticalCouplingAC	0
DC	.NET	VerticalCoupling.DC	1
	C	IVISCOPE_VAL_DC	1
	COM	IviScopeVerticalCouplingDC	1
Gnd	.NET	VerticalCoupling.Ground	2
	C	IVISCOPE_VAL_GND	2
	COM	IviScopeVerticalCouplingGnd	2
Vertical Coupling Class Ext Base	C	IVISCOPE_VAL_VERTICAL_COUPLING_CLASS_EXT_BASE	100
Vertical Coupling Specific Ext Base	C	IVISCOPE_VAL_VERTICAL_COUPLING_SPECIFIC_EXT_BASE	1000
	COM	N/A	

Trigger Coupling

Value Name	Language	Identifier	Actual Value
AC	.NET	TriggerCoupling.AC	0
	C	IVISCOPE_VAL_AC	0
	COM	IviScopeTriggerCouplingAC	0
DC	.NET	TriggerCoupling.DC	1
	C	IVISCOPE_VAL_DC	1
	COM	IviScopeTriggerCouplingDC	1
HF Reject	.NET	TriggerCoupling.HFReject	2
	C	IVISCOPE_VAL_HF_REJECT	3
	COM	IviScopeTriggerCouplingHFReject	3
LF Reject	.NET	TriggerCoupling.LFReject	3
	C	IVISCOPE_VAL_LF_REJECT	4
	COM	IviScopeTriggerCouplingLFReject	4
Noise Reject	.NET	TriggerCoupling.NoiseReject	4
	C	IVISCOPE_VAL_NOISE_REJECT	5
	COM	IviScopeTriggerCouplingNoiseReject	5
Trigger Coupling Class Ext Base	C	IVISCOPE_VAL_TRIGGER_COUPLING_CLASS_EXT_BASE	100
Trigger Coupling Specific Ext Base	C	IVISCOPE_VAL_TRIGGER_COUPLING_SPECIFIC_EXT_BASE	1000
	COM	N/A	

Trigger Slope (IVI-C & IVI-COM Only)

Value Name	Language	Identifier	Actual Value
Negative	.NET	Slope.Negative	1
	C	IVISCOPE_VAL_NEGATIVE	0
	COM	IviScopeTriggerSlopeNegative	0
Positive	.NET	Slope.Positive	0
	C	IVISCOPE_VAL_POSITIVE	1
	COM	IviScopeTriggerSlopePositive	1

Trigger Source (IVI-C & IVI-COM Only)

Value Name	Language	Identifier	Actual Value
ECL0	C	IVISCOPE_VAL_ECL0	"VAL_ECL0"
	COM	"VAL_ECL0"	"VAL_ECL0"
ECL1	C	IVISCOPE_VAL_ECL1	"VAL_ECL1"
	COM	"VAL_ECL1"	"VAL_ECL1"
External	C	IVISCOPE_VAL_EXTERNAL	"VAL_EXTERNAL"
	COM	"VAL_EXTERNAL"	"VAL_EXTERNAL"
PXI Star	C	IVISCOPE_VAL_PXI_STAR	"VAL_PXI_STAR"
	COM	"VAL_PXI_STAR"	"VAL_PXI_STAR"
RTSI0	C	IVISCOPE_VAL_RTSI_0	"VAL_RTSI_0"
	COM	"VAL_RTSI_0"	"VAL_RTSI_0"
RTSI1	C	IVISCOPE_VAL_RTSI_1	"VAL_RTSI_1"
	COM	"VAL_RTSI_1"	"VAL_RTSI_1"
RTSI2	C	IVISCOPE_VAL_RTSI_2	"VAL_RTSI_2"
	COM	"VAL_RTSI_2"	"VAL_RTSI_2"
RTSI3	C	IVISCOPE_VAL_RTSI_3	"VAL_RTSI_3"
	COM	"VAL_RTSI_3"	"VAL_RTSI_3"
RTSI4	C	IVISCOPE_VAL_RTSI_4	"VAL_RTSI_4"
	COM	"VAL_RTSI_4"	"VAL_RTSI_4"
RTSI5	C	IVISCOPE_VAL_RTSI_5	"VAL_RTSI_5"
	COM	"VAL_RTSI_5"	"VAL_RTSI_5"
RTSI6	C	IVISCOPE_VAL_RTSI_6	"VAL_RTSI_6"
	COM	"VAL_RTSI_6"	"VAL_RTSI_6"
TTL0	C	IVISCOPE_VAL_TTL0	"VAL_TTL0"
	COM	"VAL_TTL0"	"VAL_TTL0"
TTL1	C	IVISCOPE_VAL_TTL1	"VAL_TTL1"
	COM	"VAL_TTL1"	"VAL_TTL1"
TTL2	C	IVISCOPE_VAL_TTL2	"VAL_TTL2"
	COM	"VAL_TTL2"	"VAL_TTL2"
TTL3	C	IVISCOPE_VAL_TTL3	"VAL_TTL3"
	COM	"VAL_TTL3"	"VAL_TTL3"
TTL4	C	IVISCOPE_VAL_TTL4	"VAL_TTL4"
	COM	"VAL_TTL4"	"VAL_TTL4"

Value Name	Language	Identifier	Actual Value
ECL0	C	IVISCOPE_VAL_ECL0	"VAL_ECL0"
	COM	"VAL_ECL0"	"VAL_ECL0"
ECL1	C	IVISCOPE_VAL_ECL1	"VAL_ECL1"
	COM	"VAL_ECL1"	"VAL_ECL1"
TTL5	C	IVISCOPE_VAL_TTL5	"VAL_TTL5"
	COM	"VAL_TTL5"	"VAL_TTL5"
TTL6	C	IVISCOPE_VAL_TTL6	"VAL_TTL6"
	COM	"VAL_TTL6"	"VAL_TTL6"
TTL7	C	IVISCOPE_VAL_TTL7	"VAL_TTL7"
	COM	"VAL_TTL7"	"VAL_TTL7"

The following values are reserved by the IviScope specification 1.0 for the `IVISCOPE_ATTR_TRIGGER_SOURCE` attribute. Future versions of this specification cannot use these values:

"VAL_IMMEDIATE"
"VAL_GPIB_GET"
"VAL_SW_TRIG_FUNC"
"VAL_AC_LINE"

Trigger Type

Value Name	Language	Identifier	Actual Value
Edge Trigger	.NET	Trigger.Edge	0
	C	IVISCOPE_VAL_EDGE_TRIGGER	1
	COM	IviScopeTriggerEdge	1
Width Trigger	.NET	Trigger.Width	1
	C	IVISCOPE_VAL_WIDTH_TRIGGER	2
	COM	IviScopeTriggerWidth	2
Runt Trigger	.NET	Trigger.Runt	2
	C	IVISCOPE_VAL_RUNT_TRIGGER	3
	COM	IviScopeTriggerRunt	3
Glitch Trigger	.NET	Trigger.Glitch	3
	C	IVISCOPE_VAL_GLITCH_TRIGGER	4
	COM	IviScopeTriggerGlitch	4
TV Trigger	.NET	Trigger.TV	4
	C	IVISCOPE_VAL_TV_TRIGGER	5
	COM	IviScopeTriggerTV	5
Immediate Trigger	.NET	Trigger.Immediate	5
	C	IVISCOPE_VAL_IMMEDIATE_TRIGGER	6
	COM	IviScopeTriggerImmediate	6
AC Line Trigger	.NET	Trigger.ACLine	6
	C	IVISCOPE_VAL_AC_LINE_TRIGGER	7
	COM	IviScopeTriggerACLine	7
Trigger Type Class Ext Base	C	IVISCOPE_VAL_TRIGGER_TYPE_ CLASS_EXT_BASE	200
Trigger Type Specific Ext Base	C	IVISCOPE_VAL_TRIGGER_TYPE_ SPECIFIC_EXT_BASE	1000
	COM	N/A	

The following values are reserved by the IviScope specification 1.0 for the `IVISCOPE_ATTR_TRIGGER_TYPE` attribute. Future versions of this specification cannot use these values:

101
102
103
104
105

Interpolation

Value Name	Language	Identifier	Actual Value
No Interpolation	.NET	Interpolation.None	0
	C	IVISCOPE_VAL_NO_INTERPOLATION	1
	COM	IviScopeInterpolationNone	1
Sine X	.NET	Interpolation.SineXOverX	1
	C	IVISCOPE_VAL_SINE_X	2
	COM	IviScopeInterpolationSineX	2
Linear	.NET	Interpolation.Linear	2
	C	IVISCOPE_VAL_LINEAR	3
	COM	IviScopeInterpolationLinear	3
Interpolation Class Ext Base	C	IVISCOPE_VAL_INTERPOLATION_CLASS_EXT_BASE	100
Interpolation Specific Ext Base	C	IVISCOPE_VAL_INTERPOLATION_SPECIFIC_EXT_BASE	1000
	COM	N/A	

TV Trigger Event

Value Name	Language	Identifier	Actual Value
TV Event Field1	.NET	TVTriggerEvent.Field1	0
	C	IVISCOPE_VAL_TV_EVENT_FIELD1	1
	COM	IviScopeTVTriggerEventField1	1
TV Event Field2	.NET	TVTriggerEvent.Field2	1
	C	IVISCOPE_VAL_TV_EVENT_FIELD2	2
	COM	IviScopeTVTriggerEventField2	2
TV Event Any Field	.NET	TVTriggerEvent.AnyField	2
	C	IVISCOPE_VAL_TV_EVENT_ANY_FIELD	3
	COM	IviScopeTVTriggerEventAnyField	3
TV Event Any Line	.NET	TVTriggerEvent.AnyLine	3
	C	IVISCOPE_VAL_TV_EVENT_ANY_LINE	4
	COM	IviScopeTVTriggerEventAnyLine	4
TV Event Line Number	.NET	TVTriggerEvent.LineNumber	4
	C	IVISCOPE_VAL_TV_EVENT_LINE_NUMBER	5
	COM	IviScopeTVTriggerEventLineNumber	5
TV Trigger Event Class Ext Base	C	IVISCOPE_VAL_TV_TRIGGER_EVENT_CLASS_EXT_BASE	100
TV Trigger Event Specific Ext Base	C	IVISCOPE_VAL_TV_TRIGGER_EVENT_SPECIFIC_EXT_BASE	1000
	COM	N/A	

The following values are reserved by the IviScope specification 1.0 for the IVISCOPE_ATTR_TV_TRIGGER_EVENT attribute. Future versions of this specification cannot use these values:

-1

TV Trigger Signal Format

Value Name	Language	Identifier	Actual Value
NTSC	.NET	TVSignalFormat.Ntsc	0
	C	IVISCOPE_VAL_NTSC	1
	COM	IviScopeTVSignalFormatNTSC	1
PAL	.NET	TVSignalFormat.Pal	1
	C	IVISCOPE_VAL_PAL	2
	COM	IviScopeTVSignalFormatPAL	2
SECAM	.NET	TVSignalFormat.Secam	2
	C	IVISCOPE_VAL_SECAM	3
	COM	IviScopeTVSignalFormatSECAM	3
TV Signal Format Class Ext Base	C	IVISCOPE_VAL_TV_SIGNAL_FORMAT_CLASS_EXT_BASE	100
TV Signal Format Specific Ext Base	C	IVISCOPE_VAL_TV_SIGNAL_FORMAT_SPECIFIC_EXT_BASE	1000
	COM	N/A	

TV Trigger Polarity

Value Name	Language	Identifier	Actual Value
TV Positive	.NET	TVTriggerPolarity.Positive	0
	C	IVISCOPE_VAL_TV_POSITIVE	1
	COM	IviScopeTVTriggerPolarityPositive	1
TV Negative	.NET	TVTriggerPolarity.Negative	1
	C	IVISCOPE_VAL_TV_NEGATIVE	2
	COM	IviScopeTVTriggerPolarityNegative	2
TV Trigger Polarity Class Ext Base	C	IVISCOPE_VAL_TV_TRIGGER_POLARITY_CLASS_EXT_BASE	100
TV Trigger Polarity Specific Ext Base	C	IVISCOPE_VAL_TV_TRIGGER_POLARITY_SPECIFIC_EXT_BASE	1000
	COM	N/A	

Polarity (.NET Only)

Value Name	Language	Identifier	Actual Value
Trigger Polarity Positive	.NET	Polarity.Positive	0
Trigger Polarity Negative	.NET	Polarity.Negative	1
Trigger Polarity Either	.NET	Polarity.Either	2

Runt Polarity (IVI-C & IVI-COM Only)

Value Name	Language	Identifier	Actual Value
Runt Positive	C	IVISCOPE_VAL_RUNT_POSITIVE	1
	COM	IviScopeRuntPolarityPositive	1
Runt Negative	C	IVISCOPE_VAL_RUNT_NEGATIVE	2
	COM	IviScopeRuntPolarityNegative	2
Runt Either	C	IVISCOPE_VAL_RUNT_EITHER	3
	COM	IviScopeRuntPolarityEither	3

Glitch Polarity (IVI-C & IVI-COM Only)

Value Name	Language	Identifier	Actual Value
Glitch Positive	C	IVISCOPE_VAL_GLITCH_POSITIVE	1
	COM	IviScopeGlitchPolarityPositive	1
Glitch Negative	C	IVISCOPE_VAL_GLITCH_NEGATIVE	2
	COM	IviScopeGlitchPolarityNegative	2
Glitch Either	C	IVISCOPE_VAL_GLITCH_EITHER	3
	COM	IviScopeGlitchPolarityEither	3

Glitch Condition

Value Name	Language	Identifier	Actual Value
Glitch Less Than	.NET	GlitchCondition.LessThan	0
	C	IVISCOPE_VAL_GLITCH_LESS_THAN	1
	COM	IviScopeGlitchConditionLessThan	1
Glitch Greater Than	.NET	GlitchCondition.GreaterThan	1
	C	IVISCOPE_VAL_GLITCH_GREATER_THAN	2
	COM	IviScopeGlitchConditionGreaterThan	2

Width Condition

Value Name	Language	Identifier	Actual Value
Width Within	.NET	WidthCondition.Within	0
	C	IVISCOPE_VAL_WIDTH_WITHIN	1
	COM	IviScopeWidthConditionWithin	1
Width Outside	.NET	WidthCondition.Outside	1
	C	IVISCOPE_VAL_WIDTH_OUTSIDE	2
	COM	IviScopeWidthConditionOutside	2

Width Polarity (IVI-C & IVI-COM Only)

Value Name	Language	Identifier	Actual Value
Width Positive	C	IVISCOPE_VAL_WIDTH_POSITIVE	1
	COM	IviScopeWidthPolarityPositive	1
Width Negative	C	IVISCOPE_VAL_WIDTH_NEGATIVE	2
	COM	IviScopeWidthPolarityNegative	2
Width Either	C	IVISCOPE_VAL_WIDTH_EITHER	3
	COM	IviScopeWidthPolarityEither	3

AC Line Trigger Slope

Value Name	Language	Identifier	Actual Value
AC Line Positive	.NET	IviScopeACLine.Positive	0
	C	IVISCOPE_VAL_AC_LINE_POSITIVE	1
	COM	IviScopeACLinePositive	1
AC Line Negative	.NET	IviScopeACLine.Negative	1
	C	IVISCOPE_VAL_AC_LINE_NEGATIVE	2
	COM	IviScopeACLineNegative	2
AC Line Either	.NET	IviScopeACLine.Either	2
	C	IVISCOPE_VAL_AC_LINE_EITHER	3
	COM	IviScopeACLineEither	3

Sample Mode

Value Name	Language	Identifier	Actual Value
Real Time	.NET	IviScopeSampleMode.RealTime	0
	C	IVISCOPE_VAL_REAL_TIME	0
	COM	IviScopeSampleModeRealTime	0
Equivalent Time	.NET	IviScopeSampleMode.EquivalentTime	1
	C	IVISCOPE_VAL_EQUIVALENT_TIME	1
	COM	IviScopeSampleModeEquivalentTime	1

Trigger Modifier

Value Name	Language	Identifier	Actual Value
No Trigger Modifier	.NET	TriggerModifier.None	0
	C	IVISCOPE_VAL_NO_TRIGGER_MOD	1
	COM	IviScopeTriggerModifierNone	1
Auto	.NET	TriggerModifier.Auto	1
	C	IVISCOPE_VAL_AUTO	2
	COM	IviScopeTriggerModifierAuto	2
Auto Level	.NET	TriggerModifier.AutoLevel	2
	C	IVISCOPE_VAL_AUTO_LEVEL	3
	COM	IviScopeTriggerModifierAutoLevel	3
Trigger Modifier Class Ext Base	C	IVISCOPE_VAL_TRIGGER_MOD_CLASS_EXT_BASE	100
Trigger Modifier Specific Ext Base	C	IVISCOPE_VAL_TRIGGER_MOD_SPECIFIC_EXT_BASE	1000
	COM	N/A	

20.1. IviScope Obsolete Attribute Value Names

The following attribute value names are reserved by the IviScope specification 1.0. Future versions of this specification cannot use these names:

IVISCOPE_VAL_EDGE
IVISCOPE_VAL_WIDTH
IVISCOPE_VAL_RUNT
IVISCOPE_VAL_GLITCH
IVISCOPE_VAL_STATE
IVISCOPE_VAL_PATTERN
IVISCOPE_VAL_TV
IVISCOPE_VAL_IMMEDIATE
IVISCOPE_VAL_GPIB_GET
IVISCOPE_VAL_SW_TRIG_FUNC
IVISCOPE_VAL_AC_LINE
IVISCOPE_VAL_TV_SIGNAL_TYPE_CLASS_EXT_BASE
IVISCOPE_VAL_TV_SIGNAL_TYPE_SPECIFIC_EXT_BASE
IVISCOPE_VAL_TV_FIELD1
IVISCOPE_VAL_TV_FIELD2
IVISCOPE_VAL_TV_ANY_FIELD
IVISCOPE_VAL_TV_TRIGGER_FIELD_CLASS_EXT_BASE
IVISCOPE_VAL_TV_TRIGGER_FIELD_SPECIFIC_EXT_BASE
IVISCOPE_VAL_ACQ_TYPE_CLASS_EXT_BASE
IVISCOPE_VAL_ACQ_TYPE_SPECIFIC_EXT_BASE
IVISCOPE_VAL_INFINITE
IVISCOPE_VAL_50_OHMS
IVISCOPE_VAL_75_OHMS
IVISCOPE_VAL_1_MEG_OHM

21.IviScope Function Parameter Value Definitions

This section specifies the actual values for each function parameter that defines values.

Read Waveform Time Measurement (.NET Only)

Parameter: `TimeMeasurementFunction`

Value Name	Language	Identifier	Actual Value
Rise Time	.NET	<code>TimeMeasurementFunction.RiseTime</code>	0
Fall Time	.NET	<code>TimeMeasurementFunction.FallTime</code>	1
Period	.NET	<code>TimeMeasurementFunction.Period</code>	2
Width Negative	.NET	<code>TimeMeasurementFunction.WidthNegative</code>	3
Width Positive	.NET	<code>TimeMeasurementFunction.WidthPositive</code>	4

Read Waveform Measurement

Parameter: MeasurementFunction

Value Name	Language	Identifier	Actual Value
Rise Time	.NET	MeasurementFunction.RiseTime	0
	C	IVISCOPE_VAL_RISE_TIME	0
	COM	IviScopeMeasurementRiseTime	0
Fall Time	.NET	MeasurementFunction.FallTime	1
	C	IVISCOPE_VAL_FALL_TIME	1
	COM	IviScopeMeasurementFallTime	1
Frequency	.NET	MeasurementFunction.Frequency	2
	C	IVISCOPE_VAL_FREQUENCY	2
	COM	IviScopeMeasurementFrequency	2
Period	.NET	MeasurementFunction.Period	3
	C	IVISCOPE_VAL_PERIOD	3
	COM	IviScopeMeasurementPeriod	3
Voltage Rms	.NET	MeasurementFunction.VoltageRms	4
	C	IVISCOPE_VAL_VOLTAGE_RMS	4
	COM	IviScopeMeasurementVoltageRMS	4
Voltage Peak To Peak	.NET	MeasurementFunction.VoltagePeakToPeak	5
	C	IVISCOPE_VAL_VOLTAGE_PEAK_TO_PEAK	5
	COM	IviScopeMeasurementVoltagePeakToPeak	5
Voltage Max	.NET	MeasurementFunction.VoltageMax	6
	C	IVISCOPE_VAL_VOLTAGE_MAX	6
	COM	IviScopeMeasurementVoltageMax	6
Voltage Min	.NET	MeasurementFunction.VoltageMin	7
	C	IVISCOPE_VAL_VOLTAGE_MIN	7
	COM	IviScopeMeasurementVoltageMin	7
Voltage High	.NET	MeasurementFunction.VoltageHigh	8
	C	IVISCOPE_VAL_VOLTAGE_HIGH	8
	COM	IviScopeMeasurementVoltageHigh	8
Voltage Low	.NET	MeasurementFunction.VoltageLow	9
	C	IVISCOPE_VAL_VOLTAGE_LOW	9
	COM	IviScopeMeasurementVoltageLow	9

Parameter: MeasurementFunction

Value Name	Language	Identifier	Actual Value
Rise Time	.NET	MeasurementFunction.RiseTime	0
	C	IVISCOPE_VAL_RISE_TIME	0
	COM	IviScopeMeasurementRiseTime	0
Voltage Average	.NET	MeasurementFunction.VoltageAverage	10
	C	IVISCOPE_VAL_VOLTAGE_AVERAGE	10
	COM	IviScopeMeasurementVoltageAverage	10
Width Negative	.NET	MeasurementFunction.WidthNegative	11
	C	IVISCOPE_VAL_WIDTH_NEG	11
	COM	IviScopeMeasurementWidthNeg	11
Width Positive	.NET	MeasurementFunction.WidthPositive	12
	C	IVISCOPE_VAL_WIDTH_POS	12
	COM	IviScopeMeasurementWidthPos	12
Duty Cycle Negative	.NET	MeasurementFunction.DutyCycleNegative	13
	C	IVISCOPE_VAL_DUTY_CYCLE_NEG	13
	COM	IviScopeMeasurementDutyCycleNeg	13
Duty Cycle Positive	.NET	MeasurementFunction.DutyCyclePositive	14
	C	IVISCOPE_VAL_DUTY_CYCLE_POS	14
	COM	IviScopeMeasurementDutyCyclePos	14
Amplitude	.NET	MeasurementFunction.Amplitude	15
	C	IVISCOPE_VAL_AMPLITUDE	15
	COM	IviScopeMeasurementAmplitude	15
Voltage Cycle Rms	.NET	MeasurementFunction.VoltageCycleRms	16
	C	IVISCOPE_VAL_VOLTAGE_CYCLE_RMS	16
	COM	IviScopeMeasurementVoltageCycleRMS	16
Voltage Cycle Average	.NET	MeasurementFunction.VoltageCycleAverage	17
	C	IVISCOPE_VAL_VOLTAGE_CYCLE_AVERAGE	17
	COM	IviScopeMeasurementVoltageCycleAverage	17
Overshoot	.NET	MeasurementFunction.Overshoot	18
	C	IVISCOPE_VAL_OVERSHOOT	18

Parameter: MeasurementFunction

Value Name	Language	Identifier	Actual Value
Rise Time	.NET	MeasurementFunction.RiseTime	0
	C	IVISCOPE_VAL_RISE_TIME	0
	COM	IviScopeMeasurementRiseTime	0
	COM	IviScopeMeasurementOvershoot	18
Preshoot	.NET	MeasurementFunction.Preshoot	19
	C	IVISCOPE_VAL_PRESHOOT	19
	COM	IviScopeMeasurementPreshoot	19
Measurement Function Class Ext Base	C	IVISCOPE_VAL_MEASUREMENT_FUNCTION_CLASS_EXT_BASE	100
	COM	N/A	
Measurement Function Specific Ext Base	C	IVISCOPE_VAL_MEASUREMENT_FUNCTION_SPECIFIC_EXT_BASE	1000
	COM	N/A	

Parameter: MaxTimeMilliseconds

Value Name	Language	Identifier	Actual Value
Max Time Immediate	C	IVISCOPE_VAL_MAX_TIME_IMMEDIATE	0x0
	COM	IviScopeTimeOutImmediate	0x0
Max Time Infinite	C	IVISCOPE_VAL_MAX_TIME_INFINITE	0xFFFFFFFFFUL
	COM	IviScopeTimeOutInfinite	0xFFFFFFFFFUL

Fetch Waveform Measurement

Parameter: Measurement

The same as defined for the Measurement parameter of the Read Waveform Measurement function.

Read Waveform

Parameter: MaxTimeMilliseconds

The same as defined for the MaxTimeMilliseconds parameter of the Read Waveform Measurement function.

Read Min Max Waveform

Parameter: `MaxTimeMilliseconds`

The same as defined for the `MaxTimeMilliseconds` parameter of the Read Waveform Measurement function.

AcquisitionStatus

Parameter: `Status`

Value Name	Language	Identifier	Actual Value
Acquisition Complete	.NET	<code>AcquisitionStatus.Complete</code>	0
	C	<code>IVISCOPE_VAL_ACQ_COMPLETE</code>	1
	COM	<code>IviScopeAcquisitionStatusComplete</code>	1
Acquisition In Progress	.NET	<code>AcquisitionStatus.InProgress</code>	1
	C	<code>IVISCOPE_VAL_ACQ_IN_PROGRESS</code>	0
	COM	<code>IviScopeAcquisitionStatusInProgress</code>	0
Acquisition Status Unknown	.NET	<code>AcquisitionStatus.Unknown</code>	2
	C	<code>IVISCOPE_VAL_ACQ_STATUS_UNKNOWN</code>	-1
	COM	<code>IviScopeAcquisitionStatusUnknown</code>	-1

21.1. IviScope Obsolete Function Parameter Value Names

The following attribute value names are reserved for backwards compatibility. Future versions of this specification cannot use these names:

`IVISCOPE_VAL_CALCULATION_SPECIFIC_DRIVER_BASE`

22.IviScope Error and Completion Code Value Definitions

The table below specifies the actual value for each status code that the IviScope class specification defines.

Table 221. IviScope Completion Codes

Error Name	Description		
	Language	Identifier	Value(hex)
Invalid Waveform Element	One of the elements in the waveform array is invalid.		
	C	IVISCOPE_WARN_INVALID_WFM_ELEMENT	0x3FFA2001
	COM	S_IVISCOPE_INVALID_WFM_ELEMENT	0x00042001
Channel Not Enabled	Specified channel is not enabled.		
	.NET	ChannelNotEnabledException	N/A
	C	IVISCOPE_ERROR_CHANNEL_NOT_ENABLED	0xBFFA2001
	COM	E_IVISCOPE_CHANNEL_NOT_ENABLED	0x80042001
Unable To Perform Measurement	Unable to perform desired measurement operation.		
	.NET	UnableToPerformMeasurementException	N/A
	C	IVISCOPE_ERROR_UNABLE_TO_PERFORM_MEASUREMENT	0xBFFA2002
	COM	E_IVISCOPE_UNABLE_TO_PERFORM_MEASUREMENT	0x80042002
Max Time Exceeded	Maximum time exceeded before the operation completed.		
	.NET	Ivi.Driver.MaxTimeExceededException	IVI Defined Exception (See IVI-3.2)
	C	IVISCOPE_ERROR_MAX_TIME_EXCEEDED	0xBFFA2003
	COM	E_IVISCOPE_MAX_TIME_EXCEEDED	0x80042003
Invalid Acquisition Type	Invalid acquisition type.		
	.NET	InvalidAcquisitionTypeException	N/A
	C	IVISCOPE_ERROR_INVALID_ACQ_TYPE	0xBFFA2004
	COM	E_IVISCOPE_INVALID_ACQ_TYPE	0x80042004

Table 222. *IviScope Error Message Strings* defines the recommended format of the message string associated with the errors. In C, these strings are returned by the Get Error function. In COM, these strings are the description contained in the ErrorInfo object. For .NET, exception default message strings are defined with the exception.

Note: In the description string table entries listed below, %s is always used to represent the component name.

Table 222. IviScope Error Message Strings

Name	Message String
Invalid Waveform Element	“%s: Invalid waveform element
Channel Not Enabled	“%s: Channel not enabled
Unable To Perform Measurement	“%s: Unable to perform measurement
Max Time Exceeded	“%s: Maximum time exceeded”
Invalid Acquisition Type	“%s: Invalid acquisition type

22.1.IVI.NET IviScope Exceptions and Warnings

This section defines the list of IVI.NET exceptions and warnings that are specific to the IviScope class. For general information on IVI.NET exceptions and warnings, refer to *IVI-3.1: Driver Architecture Specification* and section 12, *Common IVI.NET Exceptions and Warnings*, of *IVI-3.2: Inherent Capabilities Specification*.

The IVI.NET exceptions defined in this specification are declared in the Ivi.Scope namespace.

- ChannelNotEnabledException
- InvalidAcquisitionTypeException
- UnableToPerformMeasurementException

22.1.1.ChannelNotEnabledException

Description

This exception is used when the driver finds that a channel is not enabled for measurement.

Constructors

```
Ivi.Scope.ChannelNotEnabledException(String message,  
                                     String channelName);  
  
Ivi.Scope.ChannelNotEnabledException();  
  
Ivi.Scope.ChannelNotEnabledException(String message);  
  
Ivi.Scope.ChannelNotEnabledException(String message,  
                                     System.Exception innerException);
```

Message String

The channel is not enabled for measurement.
Channel name: <channelName>

Parameters

Inputs	Description	Base Type
ChannelName	The name of the channel that is not enabled.	String

Usage

If driver developers use constructors that take a message string, they are responsible for message string localization.

22.1.2.InvalidAcquisitionTypeException

Description

This exception is used when the driver finds that an acquisition type is invalid.

Constructors

```
Ivi.Scope.AcquisitionTypeException(String message,  
                                   String acquisitionType);  
  
Ivi.Scope.AcquisitionTypeException();  
  
Ivi.Scope.AcquisitionTypeException(String message);  
  
Ivi.Scope.AcquisitionTypeException(String message,  
                                   System.Exception innerException);
```

Message String

The acquisition type is invalid.
Acquisition type: <acquisitionType>

Parameters

Inputs	Description	Base Type
acquisitionType	The invalid acquisition type.	String

Usage

If driver developers use constructors that take a message string, they are responsible for message string localization.

22.1.3.UnableToPerformMeasurementException

Description

This exception is used when the driver finds that it is unable to perform the specified measurement.

Recommended Constructors

```
Ivi.Scope.UnableToPerformMeasurementException();  
  
Ivi.Scope.UnableToPerformMeasurementException(String message);  
  
Ivi.Scope.UnableToPerformMeasurementException(String message,  
                                              System.Exception innerException);
```

Other Public Constructors

Message String

Unable to perform the specified measurement.

Usage

If driver developers use constructors that take a message string, they are responsible for message string localization.

23.IviScope Hierarchies

23.1.IviScope .NET Hierarchy

The full IviScope .NET Hierarchy includes the Inherent Capabilities Hierarchy as defined in Section 4.1, *COM Inherent Capabilities of IVI-3.2: Inherent Capabilities Specification*. To avoid redundancy, it is omitted here.

Table 231. IviScope .NET Hierarchy

.NET Interface Hierarchy	Generic Name	Type
Acquisition		
ConfigureRecord	Configure Record	M
Interpolation	Interpolation	P
NumberOfAverages	Number of Averages	P
NumberOfEnvelopes	Number of Envelopes	P
NumberOfPointsMin	Minimum Number of Points	P
RecordLength	Record Length	P
SampleMode	Sample Mode	P
SampleRate	Sample Rate	P
StartTime	Start Time	P
TimePerRecord	Time Per Record	P
Type	Type	P
Channels		
Count	Channel Count	P
Channels []	Channel item	P
Configure	Configure Channel	M
ConfigureCharacteristics	Configure Channel Characteristics	M
Coupling	Channel Coupling	P
Enabled	Channel Enabled	P
Name	Channel Name	P
Offset	Vertical Offset	P
Range	Vertical Range	P
ProbeAttenuation	Probe Attenuation	P
ProbeAutoSense	Probe Auto Sense	P
ProbeSense	Auto Probe Sense	P
InputFrequencyMaximum	Maximum Input Frequency	P
InputImpedance	Input Impedance	P
Measurement		

Table 231. IviScope .NET Hierarchy

.NET Interface Hierarchy	Generic Name	Type
FetchWaveform	Fetch Waveform	M
FetchWaveformMeasurement	Fetch Waveform Measurement	M
FetchWaveformMinMax	Fetch Min Max Waveform	M
ReadWaveform	Read Waveform	M
ReadWaveformMeasurement	Read Waveform Measurement	M
ReadWaveformMinMax	Read Min Max Waveform	M
Measurement		
Abort	Abort Acquisition	M
AutoSetup	Auto Setup	M
CreateWaveform	Create Waveform	M
Initiate	Initiate Acquisition	M
Status	Acquisition Status	M
ReferenceLevel		
Configure	Configure Reference Levels	M
High	High Reference Level	P
Low	Low Reference Level	P
Middle	Middle Reference Level	P
Trigger		
ACLine		
Slope	AC Line Trigger Slope	P
Configure	Configure Trigger	M
Continuous	Continuous Acquisition	P
Coupling	Trigger Coupling	P
Edge		
Configure	Configure Edge Trigger Source	M
Slope	Trigger Slope	P
Glitch		
Configure	Configure Glitch Trigger Source	M
Condition	Glitch Condition	P
Polarity	Glitch Polarity	P
Width	Glitch Width	P
Holdoff	Trigger Holdoff	P

Table 231. IviScope .NET Hierarchy

.NET Interface Hierarchy	Generic Name	Type
Level	Trigger Level	P
Modifier	Trigger Modifier	P
Runt		
Configure	Configure Runt Trigger Source	M
Polarity	Runt Polarity	P
ThresholdLow	Runt Low Threshold	P
ThresholdHigh	Runt High Threshold	P
Source	Trigger Source	P
TV		
Configure	Configure TV Trigger Source	M
LineNumber	TV Trigger Line Number	P
TriggerEvent	TV Trigger Event	P
Polarity	TV Trigger Polarity	P
SignalFormat	TV Trigger Signal Format	P
Type	Trigger Type	P
Width		
Configure	Configure Width Trigger Source	M
Condition	Width Condition	P
Polarity	Width Polarity	P
ThresholdLow	Width Low Threshold	P
ThresholdHigh	Width High Threshold	P

23.1.1. IviScope .NET Interfaces

In addition to implementing IVI inherent capabilities interfaces, IviScope-interfaces contain interface reference properties for accessing the following IviScope interfaces:

- IviScopeAcquisition
- IviScopeChannels
- IviScopeMeasurement
- IviScopeReferenceLevel
- IviScopeTrigger

The IviScopeTrigger interface contains interface reference properties for accessing the following IviScope trigger interfaces:

- IviScopeTriggerACLLine
- IviScopeTriggerEdge
- IviScopeTriggerGlitch
- IviScopeTriggerRunt
- IviScopeTriggerTV
- IviScopeTriggerWidth

The IviScopeChannels interface contains an interface reference operator [] for accessing the following IviScope channel interfaces:

- IviScopeChannel

The IviScopeChannel interface contains an interface reference property for accessing the following IviScope channel interface:

- IviScopeChannelMeasurement

23.1.2. IviScope .NET Interface Reference Properties

Interface reference properties are used to navigate the IviScope .NET hierarchy. This section describes the interface reference properties and operators that the IviScope, IviScopeTrigger, IviScopeChannels, and IviScopeChannel interfaces define. All interface reference properties are read-only.

Data Type	Access
IviScopeAcquisition	Acquisition
IviScopeChannels	Channels
IviScopeChannel	Channels[]
IviScopeChannelMeasurement	Channels[].Measurement
IviScopeMeasurement	Measurement
IviScopeReferenceLevel	ReferenceLevel
IviScopeTrigger	Trigger
IviScopeTriggerACLLine	Trigger.ACLine
IviScopeTriggerEdge	Trigger.Edge
IviScopeTriggerGlitch	Trigger.Glitch
IviScopeTriggerRunt	Trigger.Runt
IviScopeTriggerTV	Trigger.TV

Data Type	Access
IIviScopeTriggerWidth	Trigger.Width

23.2. IviScope COM Hierarchy

The full IviScope COM Hierarchy includes the Inherent Capabilities Hierarchy as defined in Section 4.2, *COM Inherent Capabilities of IVI-3.2: Inherent Capabilities Specification*. To avoid redundancy, it is omitted here.

Table 231. IviScope COM Hierarchy

COM Interface Hierarchy	Generic Name	Type
Acquisition		
NumberOfAverages	Number of Averages	P
NumberOfEnvelopes	Number of Envelopes	P
Interpolation	Interpolation	P
Type	Type	P
ConfigureRecord	Configure Record	M
NumberOfPointsMin	Minimum Number of Points	P
StartTime	Start Time	P
TimePerRecord	Time Per Record	P
RecordLength	Record Length	P
SampleMode	Sample Mode	P
SampleRate	Sample Rate	P
Channels		
Count	Channel Count	P
Name	Channel Name	P
Item		
Configure	Configure Channel	M
ConfigureCharacteristics	Configure Channel Characteristics	M
Coupling	Channel Coupling	P
Enabled	Channel Enabled	P
Offset	Vertical Offset	P
Range	Vertical Range	P
ProbeAttenuation	Probe Attenuation	P
ProbeSense	Auto Probe Sense	P
InputFrequencyMax	Maximum Input Frequency	P
InputImpedance	Input Impedance	P

Table 231. IviScope COM Hierarchy

COM Interface Hierarchy	Generic Name	Type
Measurements		
Count	Count	P
Name	Name	P
Abort	Abort Acquisition	M
Initiate	Initiate Acquisition	M
Status	Acquisition Status	M
IsWaveformElementInvalid	Is Invalid Waveform Element	M
AutoSetup	Auto Setup	M
Item		
FetchWaveform	Fetch Waveform	M
ReadWaveform	Read Waveform	M
FetchWaveformMinMax	Fetch Min Max Waveform	M
ReadWaveformMinMax	Read Min Max Waveform	M
FetchWaveformMeasurement	Fetch Waveform Measurement	M
ReadWaveformMeasurement	Read Waveform Measurement	M
ReferenceLevel		
Configure	Configure Reference Levels	M
Low	Low Reference Level	P
High	High Reference Level	P
Mid	Mid Reference Level	P
Trigger		
Continuous	Continuous Acquisition	P
Coupling	Trigger Coupling	P
Level	Trigger Level	P
Modifier	Trigger Modifier	P
Source	Trigger Source	P
Configure	Configure Trigger	M
Holdoff	Trigger Holdoff	P
Type	Trigger Type	P
ACLLine		
Slope	AC Line Trigger Slope	P
Edge		

Table 231. IviScope COM Hierarchy

COM Interface Hierarchy	Generic Name	Type
Configure	Configure Edge Trigger Source	M
Slope	Trigger Slope	P
Glitch		
Configure	Configure Glitch Trigger Source	M
Condition	Glitch Condition	P
Polarity	Glitch Polarity	P
Width	Glitch Width	P
Runt		
Configure	Configure Runt Trigger Source	M
Polarity	Runt Polarity	P
ThresholdLow	Runt Low Threshold	P
ThresholdHigh	Runt High Threshold	P
TV		
Configure	Configure TV Trigger Source	M
LineNumber	TV Trigger Line Number	P
Event	TV Trigger Event	P
Polarity	TV Trigger Polarity	P
SignalFormat	TV Trigger Signal Format	P
Width		
Configure	Configure Width Trigger Source	M
Condition	Width Condition	P
Polarity	Width Polarity	P
ThresholdLow	Width Low Threshold	P
ThresholdHigh	Width High Threshold	P

23.2.1. IviScope COM Interfaces

In addition to implementing IVI inherent capabilities interfaces, IviScope-interfaces contain interface reference properties for accessing the following IviScope interfaces:

- IviScopeAcquisition
- IviScopeChannels
- IviScopeMeasurements
- IviScopeReferenceLevel
- IviScopeTrigger

The IviScopeTrigger interface contains interface reference properties for accessing additional the following IviScope trigger interfaces:

- IviScopeTriggerACLLine
- IviScopeTriggerEdge
- IviScopeTriggerGlitch
- IviScopeTriggerRunt
- IviScopeTriggerTV
- IviScopeTriggerWidth

The IviScopeChannels interface contains methods and properties for accessing a collection of objects that implement the IviScopeChannel interface.

The IviScopeMeasurements interface contains methods and properties for accessing a collection of objects that implement the IviScopeChannel interface.

Table 232. IviScope Interface GUIDs lists the interfaces that this specification defines and their GUIDs.

Table 232. IviScope Interface GUIDs

Interface	GUID
IviScope	{ 47ed524c-a398-11d4-ba58-000064657374 }
IviScopeAcquisition	{ 47ed524d-a398-11d4-ba58-000064657374 }
IviScopeChannels	{ 47ed524e-a398-11d4-ba58-000064657374 }
IviScopeChannel	{ 47ed524f-a398-11d4-ba58-000064657374 }
IviScopeMeasurements	{ 47ed5251-a398-11d4-ba58-000064657374 }
IviScopeMeasurement	{ 47ed5252-a398-11d4-ba58-000064657374 }
IviScopeReferenceLevel	{ 47ed5250-a398-11d4-ba58-000064657374 }
IviScopeTrigger	{ 47ed5253-a398-11d4-ba58-000064657374 }
IviScopeTriggerACLLine	{ 47ed5254-a398-11d4-ba58-000064657374 }
IviScopeTriggerEdge	{ 47ed5255-a398-11d4-ba58-000064657374 }
IviScopeTriggerGlitch	{ 47ed5256-a398-11d4-ba58-000064657374 }
IviScopeTriggerRunt	{ 47ed5257-a398-11d4-ba58-000064657374 }
IviScopeTriggerTV	{ 47ed5258-a398-11d4-ba58-000064657374 }
IviScopeTriggerWidth	{ 47ed5259-a398-11d4-ba58-000064657374 }

23.2.2. IviScope COM Interface Reference Properties

Interface reference properties are used to navigate the IviScope COM hierarchy. This section describes the interface reference properties that the IviScope and IviScopeTrigger interfaces define.

Data Type	Access
IviScopeAcquisition*	Acquisition
IviScopeChannels*	Channels
IviScopeChannel*	Channel
IviScopeMeasurements*	Measurements
IviScopeMeasurement*	Measurement
IviScopeReferenceLevel*	ReferenceLevel
IviScopeTrigger*	Trigger
IviScopeTriggerACLLine*	ACLLine
IviScopeTriggerEdge*	Edge
IviScopeTriggerGlitch*	Glitch
IviScopeTriggerRunt*	Runt
IviScopeTriggerTV*	TV
IviScopeTriggerWidth*	Width

23.2.3. IviScope COM Category

The IviScope class COM Category shall be “IviScope”, and the Category ID (CATID) shall be {47ed5156-a398-11d4-ba58-000064657374}.

23.3. IviScope C Function Hierarchy

The IviScope class function hierarchy is shown in the following table.

Name or Class	Function Name
Configuration...	
Acquisition...	
Configure Acquisition Type	IviScope_ConfigureAcquisitionType
Configure Acquisition Record	IviScope_ConfigureAcquisitionRecord
Configure Number of Averages	IviScope_ConfigureNumAverages
Configure Number of Envelopes	IviScope_ConfigureNumEnvelopes
Configure Interpolation	IviScope_ConfigureInterpolation
Configure Initiate Continuous	IviScope_ConfigureInitiateContinuous
Channel...	
Get Channel Name	IviScope_GetChannelName

Name or Class	Function Name
Configure Channel	IviScope_ConfigureChannel
Configure Channel Characteristics	IviScope_ConfigureChanCharacteristics
Trigger...	
Configure Trigger	IviScope_ConfigureTrigger
Configure Trigger Coupling	IviScope_ConfigureTriggerCoupling
Configure Trigger Modifier	IviScope_ConfigureTriggerModifier
Configure Edge Trigger Source	IviScope_ConfigureEdgeTriggerSource
Configure TV Trigger Source	IviScope_ConfigureTVTriggerSource
Configure TV Trigger Ln Number	IviScope_ConfigureTVTriggerLineNumber
Configure Runt Trigger Source	IviScope_ConfigureRuntTriggerSource
Configure Glitch Trigger Source	IviScope_ConfigureGlitchTriggerSource
Configure Width Trigger Source	IviScope_ConfigureWidthTriggerSource
Configure AC Line Trigger Slope	IviScope_ConfigureAcLineTriggerSlope
Measurement	
Configure Reference Levels	IviScope_ConfigureRefLevels
Configuration Information...	
Actual Record Length	IviScope_ActualRecordLength
Auto Probe Sense Value	IviScope_AutoProbeSenseValue
Actual Sample Mode	IviScope_SampleMode
Actual Sample Rate	IviScope_SampleRate
Auto Setup	IviScope_AutoSetup
Waveform Acquisition...	
Read Waveform	IviScope_ReadWaveform
Read Min/Max Waveform	IviScope_ReadMinMaxWaveform
Read Waveform Measurement	IviScope_ReadWaveformMeasurement
Low-Level Acquisition...	
Initiate Acquisition	IviScope_InitiateAcquisition
Acquisition Status	IviScope_AcquisitionStatus
Fetch Waveform	IviScope_FetchWaveform
Fetch Min/Max Waveform	IviScope_FetchMinMaxWaveform
Fetch Waveform Measurement	IviScope_FetchWaveformMeasurement
Abort	IviScope_Abort

Name or Class	Function Name
Utility... Is Invalid Wfm Element	IviScope_IsInvalidWfmElement

23.3.1. IviScope Obsolete Function Names

The following function names are reserved by the IviScope specification 1.0. The future versions of this specification cannot use these names:

- `IviScope_ConfigureAcquisition`
- `IviScope_ConfigureEdgeTrigger`
- `IviScope_ConfigureGlitchTrigger`
- `IviScope_ConfigureHorizontal`
- `IviScope_ConfigureRuntTrigger`
- `IviScope_ConfigureTVTrigger`
- `IviScope_ConfigureTriggerSource`
- `IviScope_ConfigureVertical`
- `IviScope_ConfigureWidthTrigger`
- `IviScope_SendSWTrigger`

23.4. IviScope C Attribute Hierarchy

The IviScope class attribute hierarchy is shown in the following table.

Table 233. IviScope C Attributes Hierarchy

Category or Generic Attribute Name	C Defined Constant
<i>Acquisition</i>	
Acquisition Start Time	IVISCOPE_ATTR_ACQUISITION_START_TIME
Acquisition Type	IVISCOPE_ATTR_ACQUISITION_TYPE
Horizontal Minimum Number of Points	IVISCOPE_ATTR_HORZ_MIN_NUM_PTS
Horizontal Record Length	IVISCOPE_ATTR_HORZ_RECORD_LENGTH
Horizontal Sample Rate	IVISCOPE_ATTR_HORZ_SAMPLE_RATE
Horizontal Time Per Record	IVISCOPE_ATTR_HORZ_TIME_PER_RECORD
Interpolation	IVISCOPE_ATTR_INTERPOLATION
Sample Mode	IVISCOPE_ATTR_SAMPLE_MODE
Number of Averages	IVISCOPE_ATTR_NUM_AVERAGES
Number of Envelopes	IVISCOPE_ATTR_NUM_ENVELOPES
Initiate Continuous	IVISCOPE_ATTR_INITIATE_CONTINUOUS
<i>Channel</i>	
Channel Count	IVISCOPE_ATTR_CHANNEL_COUNT
Channel Enabled	IVISCOPE_ATTR_CHANNEL_ENABLED
Probe Attenuation	IVISCOPE_ATTR_PROBE_ATTENUATION
Probe Sense Value	IVISCOPE_ATTR_PROBE_SENSE_VALUE
Vertical Range	IVISCOPE_ATTR_VERTICAL_RANGE
Vertical Offset	IVISCOPE_ATTR_VERTICAL_OFFSET
Vertical Coupling	IVISCOPE_ATTR_VERTICAL_COUPLING
Maximum Input Frequency	IVISCOPE_ATTR_MAX_INPUT_FREQUENCY
Input Impedance	IVISCOPE_ATTR_INPUT_IMPEDANCE
<i>Trigger</i>	
Trigger Type	IVISCOPE_ATTR_TRIGGER_TYPE
Trigger Source	IVISCOPE_ATTR_TRIGGER_SOURCE

Table 233. IviScope C Attributes Hierarchy

Category or Generic Attribute Name	C Defined Constant
Trigger Coupling	IVISCOPE_ATTR_TRIGGER_COUPLING
Trigger Holdoff	IVISCOPE_ATTR_TRIGGER_HOLDOFF
Trigger Level	IVISCOPE_ATTR_TRIGGER_LEVEL
Trigger Modifier	IVISCOPE_ATTR_TRIGGER_MODIFIER
<i>Edge Triggering</i>	
Trigger Slope	IVISCOPE_ATTR_TRIGGER_SLOPE
<i>TV Triggering</i>	
TV Trigger Signal Format	IVISCOPE_ATTR_TV_TRIGGER_SIGNAL_FORMAT
TV Trigger Event	IVISCOPE_ATTR_TV_TRIGGER_EVENT
TV Trigger Line Number	IVISCOPE_ATTR_TV_TRIGGER_LINE_NUMBER
TV Trigger Polarity	IVISCOPE_ATTR_TV_TRIGGER_POLARITY
<i>Runt Triggering</i>	
Runt High Threshold	IVISCOPE_ATTR_RUNT_HIGH_THRESHOLD
Runt Low Threshold	IVISCOPE_ATTR_RUNT_LOW_THRESHOLD
Runt Polarity	IVISCOPE_ATTR_RUNT_POLARITY
<i>Glitch Triggering</i>	
Glitch Width	IVISCOPE_ATTR_GLITCH_WIDTH
Glitch Polarity	IVISCOPE_ATTR_GLITCH_POLARITY
Glitch Condition	IVISCOPE_ATTR_GLITCH_CONDITION
<i>Width Triggering</i>	
Width Condition	IVISCOPE_ATTR_WIDTH_CONDITION
Width High Threshold	IVISCOPE_ATTR_WIDTH_HIGH_THRESHOLD
Width Low Threshold	IVISCOPE_ATTR_WIDTH_LOW_THRESHOLD
Width Polarity	IVISCOPE_ATTR_WIDTH_POLARITY
<i>AC Line Triggering</i>	
AC Line Trigger Slope	IVISCOPE_ATTR_AC_LINE_TRIGGER_SLOPE
<i>Waveform Measurement</i>	

Table 233. IviScope C Attributes Hierarchy

Category or Generic Attribute Name	C Defined Constant
Measurement High Reference	IVISCOPE_ATTR_MEAS_HIGH_REF
Measurement Low Reference	IVISCOPE_ATTR_MEAS_LOW_REF
Measurement Middle Reference	IVISCOPE_ATTR_MEAS_MID_REF

A. Specific Driver Development Guidelines

1. Introduction

This section describes situations driver developers should be aware of when developing a specific instrument driver that complies with the IviScope class.

2. Disabling Unused Extensions

IVI Class-Compliant specific drivers are required to disable extension capability groups that an application program does not explicitly use. The IVI Class-Compliant specific driver can do so by setting the attributes of an extension capability group to the values that this section recommends. An IVI Class-Compliant specific driver can set these values for all extension capability groups when the Initialize, and Reset functions execute. This assumes that the extension capability groups remain disabled until the application program explicitly uses them. For the large majority of instruments, this assumption is true.

Under certain conditions, an IVI Class-Compliant specific driver might have to implement a more complex approach. For some instruments, configuring a capability group might affect instrument settings that correspond to an unused extension capability group. If these instrument settings affect the behavior of the instrument, then this might result in an interchangeability problem. If this can occur, the IVI Class-Compliant specific driver must take appropriate action so that the instrument settings that correspond to the unused extension capability group do not affect the behavior of the instrument when the application program performs an operation that might be affected by those settings.

The remainder of this section recommends attribute values that effectively disable each extension capability group.

Disabling the IviScopeInterpolation Extension Group

Attribute value that effectively disables the IviScopeInterpolation extension group is shown in the following table.

Table 234. Values for Disabling the IviScopeInterpolation Extension Group

Attribute	Value
Interpolation	No Interpolation

Disabling the IviScopeTVTrigger Extension Group

The IviScopeTVTrigger extension group affects the instrument behavior only when the Trigger Type attribute is set to TV Trigger value. Therefore, this specification does not recommend attribute values that disable the IviScopeTVTrigger extension group.

Disabling the IviScopeRuntTrigger Extension Group

The IviScopeRuntTrigger extension group affects the instrument behavior only when the Trigger Type attribute is set to Runt Trigger. Therefore, this specification does not recommend attribute values that disable the IviScopeRuntTrigger extension group.

Disabling the IviScopeGlitchTrigger Extension Group

The IviScopeGlitchTrigger extension group affects the instrument behavior only when the Trigger Type attribute is set to Glitch Trigger. Therefore, this specification does not recommend attribute values that disable the IviScopeGlitchTrigger extension group.

Disabling the IviScopeWidthTrigger Extension Group

The IviScopeWidthTrigger extension group affects the instrument behavior only when the Trigger Type attribute is set to Width Trigger. Therefore, this specification does not recommend attribute values that disable the IviScopeWidthTrigger extension group.

Disabling the IviScopeACLineTrigger Extension Group

The IviScopeACLineTrigger extension group affects the instrument behavior only when the Trigger Type attribute is set to AC Line Trigger. Therefore, this specification does not recommend attribute values that disable the IviScopeACLineTrigger extension group.

Disabling the IviScopeWaveformMeasurement Extension Group

The IviScopeWaveformMeasurement extension group affects the instrument behavior only when the end user calls the Read Waveform Measurement or Fetch Waveform Measurement functions. Therefore, this specification does not recommend attribute values that disable the IviScopeWaveformMeasurement extension group.

Disabling the IviScopeMinMaxWaveform Extension Group

The IviScopeMinMaxWaveform extension group affects the instrument behavior only when the Acquisition Type attribute is set to Envelope or Peak Detect. Therefore, this specification does not recommend attribute values that disable the IviScopeMinMaxWaveform extension group.

Disabling the IviScopeProbeAutoSense Extension Group

The IviScopeProbeAutoSense extension group defines the read-only attributes and functions that analyze the instrument's state. These attributes and functions do not affect the instrument behavior.

Disabling the IviScopeContinuousAcquisition Extension Group

Attribute value that effectively disables the IviScopeContinuousAcquisition extension group is shown in the following table.

Table 235. Values for Disabling the IviScopeContinuousAcquisition Extension Group

Attribute	Value
Initiate Continuous	False

Disabling the IviScopeAverageAcquisition Extension Group

The IviScopeAverageAcquisition extension group affects the instrument behavior only when the Acquisition Type attribute is set to Average. Therefore, this specification does not recommend attribute values that disable the IviScopeAverageAcquisition extension group.

Disabling the IviScopeSampleMode Extension Group

The IviScopeSampleMode extension group defines the read-only attributes and functions that analyze the instrument's state. These attributes and functions do not affect the instrument behavior.

Disabling the IviScopeTriggerModifier Extension Group

Attribute value that effectively disables the IviScopeTriggerModifier extension group is shown in the following table.

Table 236. Values for Disabling the IviScopeTriggerModifier Extension Group

Attribute	Value
Trigger Modifier	No Trigger Mod

Disabling the IviScopeAutoSetup Extension Group

The IviScopeAutoSetup extension group affects the instrument behavior only when the end user calls the Auto Setup function. Therefore, this specification does not recommend attribute values that disable the IviScopeAutoSetup extension group.

3. Query Instrument Status

Based on the value of Query Instrument Status, the IVI Class-Compliant specific driver may check the status of the instrument to see if it has encountered an error. In IVI Class-Compliant specific driver functions, the status check should not occur in the lowest-level signal generation functions Initiate Acquisition, Abort, Fetch Waveform, Fetch Min Max Waveform, and Fetch Waveform Measurement. These functions are intended to give the application developer low-level control over signal generation. When calling these functions, the application developer is responsible for checking the status of the instrument. Checking status in every function at this level would also add unnecessary overhead to the specific instrument driver.

4. Relationship of Acquisition Type and Horizontal Minimum Number of Points attributes

The end-user sets the Horizontal Minimum Number of Points attribute to specify the number of points they want to acquire into the oscilloscope's waveform record. Most oscilloscopes accept only a discrete set of record lengths, but not necessarily the same discrete set. The set of acceptable record lengths varies from one oscilloscope to another. You must make sure that the value the driver writes to the instrument is the exact number that the instrument accepts, regardless of whether the oscilloscope coerces values. This ensures that the cache value of the attribute truly reflects the state of the oscilloscope. At the same time, the driver must remember the minimum number of points the user requests. It is possible for other settings to change the set of valid record lengths. When the user initiates an acquisition, the driver must verify that the current record length is greater than or equal to the minimum number of points.

5. Auto-Setup and attribute invalidations

When the end-user calls the Auto Setup function, the oscilloscope senses the input signal and configures many of the instrument settings automatically. If the driver is using state caching, the cache value of the instrument driver attributes that correspond to the settings the oscilloscope changes no longer reflect the state of the instrument. Therefore, you must invalidate the cache value of all the attributes. You can do this with the Invalidate All Attributes function.

6. Suggestions for Implementing the Probe Attenuation Attribute

You must pay particular attention to oscilloscopes that have the ability to sense the attenuation of the probe and to adjust other settings accordingly. The possible approach is the implementation of two additional attributes, Probe Sense Value and Probe Sense in your driver. Probe Sense Value is an extension attribute defined in the IviScopeProbeAutoSense Extension section of this specification. Probe Sense is an instrument specific attribute that is used internally by the driver to record whether the instrument is currently using the probe sensing capability. The driver uses these attributes to calculate the valid ranges for other attributes that are dependent upon the probe attenuation attribute. These attributes include Vertical Range, Vertical Offset, and all the attributes that configure trigger levels.

The different scenarios include:

- The oscilloscope does not have the probe sense capability. The only valid settings for the Probe Attenuation attribute are manual probe attenuation values.
 - To handle this case, do not allow the Probe Attenuation attribute to be set to the Probe Sense On value.
- The oscilloscope can sense the probe attenuation, and it also allows the user to specify a manual attenuation setting.
 - To handle this case, implement the Probe Sense Value and Probe Sense attributes. When the end-user enables the automatic probe sense capability or the instrument driver reads from the instrument that automatic probe sense is enabled, and the driver implements the state caching, the driver must disable state caching for the dependent attributes. When the end-user disables the automatic probe sense capability or the instrument driver reads from the instrument that it is using manual probe attenuation, the driver must enable state caching for the dependent attributes.
- The oscilloscope can sense the probe attenuation, but it does not accept any manual settings.

Allow the users to specify manual settings and assume that the instrument operator does not replace the probe after the application program specifies the manual setting. Notice that this is the same assumption that you must always make when using manual settings on any oscilloscope.

To allow for manual settings, check if the user sets the attribute to an acceptable value. The acceptable values are Probe Sense On or the actual probe attenuation the oscilloscope is currently sensing. You must implement the Probe Sense Value and `IVISCOPE_ATTR_PROBE_SENSE` attributes as in the previous case.

7. *Attributes that use the Probe Attenuation attribute*

Many attributes depend on the value of the Probe Attenuation attribute. These attributes include the Vertical Range, Vertical Offset, and Trigger Level attributes. Attributes that depend on the value of the Probe Attenuation attribute typically use the probe attenuation value to check and coerce the value the end-user specifies for them. When you implement these attributes, make sure that you always perform the checking against the actual probe attenuation value.

8. *Relationship of the Vertical Coupling and Trigger Coupling attributes*

In most cases, oscilloscopes have the circuitry for performing the coupling on the acquisition channel separate from the circuitry that performs the coupling on the trigger subsystem. This specification assumes that the instrument can set the channel coupling independently from the trigger coupling. If this is not the case, the IVI Class-Compliant specific driver must implement the Vertical Coupling as the dominant attribute. This means that setting this attribute to a value allowed by the instrument always results in the successful operation. On such instruments, setting the Trigger Coupling attribute to anything that conflicts with the specified channel coupling must cause an Invalid Value error.

9. *Instruments that have channel-based record lengths*

Most oscilloscopes have the same record length on all acquisition channels. This specification assumes that the setting for the record length is a global setting for all channels, and it uses Horizontal Minimum Number of Points and Horizontal Record Length to model this behavior. If the instrument has different acquisition lengths on different channels, then the class behavior would dictate setting all of the channels to the same value with the Horizontal Minimum Number of Points. The different record lengths must be modeled as an instrument specific behavior.

10. *Implementing the Trigger Holdoff attribute*

This specification defines the hold-off as the length of time the oscilloscope waits after it detects a trigger until it responds to additional triggers. Many analog oscilloscopes define the hold-off as starting from end of the previous waveform acquisition instead of from the previous trigger. Some digital oscilloscopes specify the hold-off from the end of the waveform acquisition as well.

These differences in how oscilloscopes specify the hold-off setting can lead to non-interchangeable instruments behavior. Therefore if your instrument defines the hold-off as starting from the end of the previous waveform acquisition, you **must** translate that hold-off time to the one defined in this specification. To do that, you may do the following:

1. Translate the value the end-user specifies for hold-off to a value your oscilloscope expects when you implement the attribute. You can do this by subtracting the length of time from the Trigger Event to the end of the waveform record from the hold-off value the user specifies. Then send the resulting number to the oscilloscope. If the number is less than 0.0, use 0.0.
2. Perform the opposite translation when obtaining the value from the instrument.
3. Since it now depends on the acquisition settings, make sure that setting the Acquisition Start Time, Horizontal Time Per Second, and Horizontal Minimum Number of Points attributes invalidates the Trigger Holdoff attribute.

B. Interchangeability Checking Rules

B.1 Introduction

IVI drivers may have a feature called interchangeability checking. Interchangeability checking returns a warning when it encounters a situation where the application program might not produce the same behavior when the user attempts to use a different instrument.

B.2 When to Perform Interchangeability Checking

Refer to Section 3.3.6: *Interchangeability Checking in IVI-3.1: Driver Architecture Specification* for a description of the rules for interchangeability checking in IVI drivers. The remainder of this section defines additional rules and exceptions for each capability group.

Interchangeability checking occurs when all of the following conditions are met:

- The Interchange Check attribute is set to True
- The user calls one of the following functions.
 - Initiate Acquisition
 - Read Waveform
 - Read Min Max Waveform
 - Read Waveform Measurement

B.3 Interchangeability Checking Rules

Interchangeability checking is performed on a capability group basis. When enabled, interchangeability checking is always performed on the base capability group. In addition, interchangeability checking is performed on extension capability groups for which the user has ever set any of the attributes of the group. If the user has never set any attributes of an extension capability group, interchangeability checking is not performed on that group.

In general interchangeability warnings are generated if the following conditions are encountered:

- An attribute that affects the behavior of the instrument is not in a state that the user specifies.
- The user sets a class driver defined attribute to an instrument-specific value.
- The user configures the value of an attribute that the class defines as read-only. In a few cases the class drivers define read-only attributes that specific drivers might implement as read/write.

The remainder of this section defines additional rules and exceptions for each capability group.

IviScopeBase Capability Group

No additional interchangeability rules or exceptions are defined for the IviScopeBase capability group.

IviScopeInterpolation Capability Group

The Interpolation attribute must be in a user specified state only if the application sets the Acquisition Type attribute to Average.

IviScopeTVTrigger Capability Group

1. The driver performs interchangeability checking on the IviScopeTVTrigger group only if the application sets the Trigger Type attribute to TV Trigger.
2. The TV Trigger Line Number attribute must be in a user specified state only if the application sets the TV Trigger Event attribute to TV Event Line Number.

IviScopeRuntTrigger Capability Group

1. The driver performs interchangeability checking on the IviScopeRuntTrigger group only if the application sets the Trigger Type attribute to Runt Trigger.
2. The Trigger Level attribute must be in a user-specified state only if the application sets the Trigger Type attribute to Runt Trigger.

IviScopeGlitchTrigger Capability Group

The driver performs interchangeability checking on the IviScopeGlitchTrigger group only if the application sets the Trigger Type attribute to Glitch Trigger.

IviScopeWidthTrigger Capability Group

The driver performs interchangeability checking on the IviScopeWidthTrigger group only if the application sets the Trigger Type attribute to Width Trigger.

IviScopeAcLineTrigger Capability Group

The driver performs interchangeability checking on the IviScopeAcLineTrigger group only if the application sets the Trigger Type attribute to AC Line Trigger.

IviScopeWaveformMeas Capability Group

1. The Measurement Low Reference attribute must be in a user-specified state if the user requests a waveform measurement that requires the low reference level, such as rise time, fall time, preshoot and overshoot.
2. The Measurement Middle Reference attribute must be in a user-specified state if the user requests a waveform measurement that requires the middle reference level, such as frequency, period, positive and negative pulse widths, and all cycle-based measurements.
3. The Measurement High Reference attribute must be in a user-specified state if the user requests a waveform measurement that requires the high reference level, such as rise time, fall time, preshoot and overshoot.

IviScopeMinMaxWaveform Capability Group

1. The driver performs interchangeability checking on the IviScopeMinMaxWaveform group only if the application sets the Acquisition Type attribute to Envelope or Peak Detect.
3. The Number of Envelopes attribute must be in a user-specified state only if the application sets the Acquisition Type attribute to Envelope.

IviScopeProbeAutoSense Capability Group

No additional interchangeability rules or exceptions are defined for the IviScopeProbeAutoSense capability group.

IviScopeContinuousAcquisition Capability Group

Using this extension group is inherently non-interchangeable. This specification does not define the behavior of the instrument nor the data the instruments return while continuously acquiring the data.

IviScopeAverageAcquisition Capability Group

The driver performs interchangeability checking on the IviScopeAverageAcquisition group only if the application sets the Acquisition Type attribute to Average.

IviScopeSampleMode Capability Group

No additional interchangeability rules or exceptions are defined for the IviScopeSampleMode capability group.

IviScopeTriggerModifier Capability Group

No additional interchangeability rules or exceptions are defined for the IviScopeTriggerModifier capability group.

IviScopeAutoSetup Capability Group

Using this extension group is inherently non-interchangeable. The application behavior then depends on the internal instrument's algorithms for optimal acquisition and channel configuration.